

## ERM-202

# Single or Dual Channel Polarization Extinction Ratio Measurement System

---



## User Guide

Version: 1.1  
Date: May 21, 2015

**General Photonics, Incorporated is located in Chino California.**

**For more information visit the company's website at:**

**[www.generalphotonics.com](http://www.generalphotonics.com)**

**or call 909-590-5473**

### SAFETY CONSIDERATIONS

The following safety precautions must be observed during operation of this product. Failure to comply with these precautions or with specific warnings elsewhere in this manual violates safety standards of design, manufacture, and intended use of the product. General Photonics assumes no liability for customers' failure to comply with these requirements.

**Before operation, the user should inspect the product and review the manual carefully.**

Properly ground the chassis and work space using the chassis ground terminal.

Use only in a safe work environment in terms of temperature, humidity, electrical power and risk of fire or shock. The product is designed for indoor use. Avoid exposure to liquids or water condensation. Provide adequate ventilation for cooling.

Operate the product on a stable surface. Avoid excess vibration.

Standard laser safety procedures should be followed during operation.

***Never look into the light source fiber connector when the light source is turned on. THE OUTPUT LIGHT FROM A HIGH POWER LASER IS HARMFUL TO HUMAN EYES. Follow industry standard procedures when operating a high power laser source.***



<b>Section 1.0</b>	<b>Overview .....</b>	<b>7</b>
1.1	Principle of Operation.....	7
<b>Section 2.0</b>	<b>Features .....</b>	<b>9</b>
2.1	Front Panel and Optical Inputs .....	9
2.2	Rear Panel: Electrical and Remote Control Interfaces .....	11
<b>Section 3.0</b>	<b>Operation Instructions .....</b>	<b>13</b>
3.1	Unpacking .....	13
3.2	Front Panel Operation .....	13
3.3	Measurement Modes.....	15
<u>PER/Power</u>	.....	<u>15</u>
<u>Two-Input Power Ratio Measurement (ERM-202-2 only)</u>	.....	<u>15</u>
<u>for PM coupler characterization</u>	.....	<u>15</u>
<u>ER Maximum/Minimum Search Mode (ERM-202-1 only)</u>	.....	<u>16</u>
<u>Angle Measurement Mode (ERM-202-2 only)</u>	.....	<u>17</u>
<u>DOP Estimation Mode</u>	.....	<u>17</u>
<u>Manual Polarizer Control Mode (ERM-202-1 only)</u>	.....	<u>18</u>
3.4	Additional Features .....	19
<u>Analog Monitor Voltage</u>	.....	<u>19</u>
<u>Data Storage and Recall</u>	.....	<u>20</u>
<u>Setup Parameters</u>	.....	<u>21</u>
3.5	Troubleshooting .....	29
<u>Front Panel</u>	.....	<u>29</u>
<u>Remote Control</u>	.....	<u>29</u>
<b>Section 4.0</b>	<b>Specifications .....</b>	<b>31</b>
<u>Optical</u>	.....	<u>31</u>
<u>Electrical</u>	.....	<u>31</u>
<u>Physical and Environmental</u>	.....	<u>31</u>

Appendices ..... 33

    Appendix 1.0 Remote Control Commands ..... 33  
        Command Lists.....33

    Appendix 2.0 RS-232 connection and setup ..... 39

    Appendix 3.0 USB connection and setup ..... 41  
        USB Driver Installation .....41

    Appendix 4.0 Ethernet setup..... 47  
        Front Panel.....48  
        LabView program .....48

    Appendix 5.0 GPIB setup and control..... 52  
        GPIB control.....52

    Appendix 6.0 LabView control program ..... 53  
        RS-232/USB/GPIB .....53  
        Ethernet .....54  
        Program Interface.....55

## Section 1.0 Overview

General Photonics' ERM-202 series of polarization extinction ratio (PER) meters provide fast, accurate measurement of the polarization extinction ratio, polarization angle, and power of input light beams. The dual channel version also automatically measures the coupling and power ratios between the two channels. The instrument contains one or two optical measurement modules, each consisting of a rotating polarizer driven by a motor.



Figure 1 (a) Dual and (b) single-channel polarization extinction ratio meters

### 1.1 Principle of Operation

Polarization extinction ratio (PER) is the ratio between the power in the principal polarization component of a light beam and the power in the orthogonal polarization component, expressed in dB. It is a measure of the linearity and degree of polarization of a polarized light source, or of the polarization preserving or suppressing properties of a fiber or optical component. A typical laboratory setup for measuring PER uses a rotating polarizer placed after the light source under test, as shown in Figure 2.

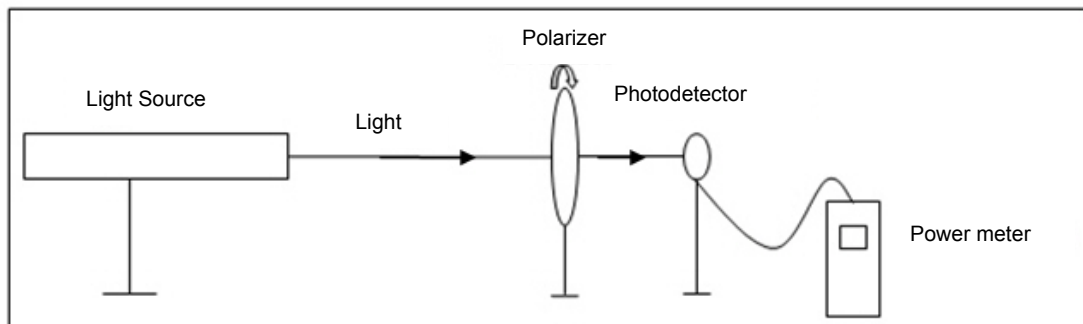

Figure 2 Laboratory ER measurement setup

The polarizer is rotated 360 degrees, and the maximum and minimum output power in mW is recorded. The PER is then calculated using the following equation:

$$PER = 10 \log_{10} \frac{P_{\max}}{P_{\min}} \text{ (dB)}$$

This measurement also yields the direction of polarization of the light. The angle of polarization is defined as the angle of the polarizer's transmission axis at maximum output optical power, relative to some reference direction.

For example, for the case of a linearly polarized light source, most of the light will be polarized along the principal axis of polarization, with very little power in the orthogonal component. The PER can be  $> 40\text{dB}$ , i.e., the power ratio between the two orthogonal polarizations is  $> 10^4$ .

By contrast, in an ASE light source, the linearity of the polarization is poor due to broadband spontaneous emission. Its PER will be close to  $0\text{dB}$ , indicating that the optical power is distributed approximately equally in all polarization angles.



## Section 2.0 Features

### 2.1 Front Panel and Optical Inputs

The front panel of the ER meter is shown in Figure 3 and Figure 4. It contains the power switch (Power), organic light-emitting diode display (OLED), push button control pads, and optical input port(s). The input ports are free space, so they can accept either flat or angle polished input fiber connectors (see function menu for connector type selection). For the standard 1260-1620nm ER meter, input power should be between  $-30$  and  $+10$  dBm. If the input power is too low, the screen will display "Optical Power Low!"

External fiber connectors should be cleaned using industry standard cleaning methods before connection to the ERM-202. Dirty connectors can affect measurement accuracy.



Figure 3 Dual Channel ER meter front panel

Front panel features:

OLED display: displays data and operation mode information

Power: power on/off switch

Input: adapter for optical fiber input

Keypad: push buttons for measurement status control

AUTO1: Begins automatic PER measurement for channel 1

AUTO2: Begins automatic PER measurement for channel 2

STOP 1: Stops measurement for channel 1.

STOP 2: Stops measurement for channel 2.

STORE: Store currently displayed measurement values.

RECALL: Recall stored measurement values.

LOCAL: Returns the ER meter to front panel control from remote control.

FUNC: Accesses operation parameter setup.

## ERM-202 User Guide

ENTER: Enters measurement parameters set with arrow keys, accesses alternate operation modes.

▲  
◀ ▶: Select and set measurement parameters.  
▼



Figure 4 Single Channel ER meter front panel

Front panel features:

OLED display: displays data and operation mode information

Power: power on/off switch

Input: adapter for optical fiber input

Keypad: push buttons for measurement status control

AUTO: Begins automatic PER measurement (default setting)

CYCLE: Set the number of polarizer rotation cycles for averaging (default value is 1 cycle).

MANUAL: Manual polarizer rotation control.

STOP: Stops measurement.

STORE: Store currently displayed measurement values.

RECALL: Recall stored measurement values.

SPEED: Set scanning time for one polarizer rotation cycle (default is 0.4s)

FUNC: Accesses operation parameter setup.

ENTER: Enters measurement parameters set with arrow keys, accesses alternate operation modes, returns the ER meter to front panel control from remote control.

▲  
◀ ▶: Select and set measurement parameters.  
▼

## 2.2 Rear Panel: Electrical and Remote Control Interfaces

The AC power plug, fuse, and communication interface connectors are mounted on the rear panel, as shown in Figure 5.

The ERM-202 includes RS-232, USB, Ethernet, and GPIB interfaces for external computer operation of the system. LabView™ (National Instruments, [www.ni.com](http://www.ni.com)) control programs are provided. Control commands, USB driver installation instructions, and instructions for running control programs are located in the appendices.



Figure 5 ER meter rear panel

Rear Panel Features:

USB 2.0 interface port	Line: External AC input connector
RS-232 serial interface port	Cooling fan air intake
Ethernet interface port	⏏: Chassis ground
GPIB interface port	
SR30 4-pin connector: Analog interface port	

### Fuse location:

Figure 6 shows the location of the fuse compartment under the power cord plug. There are two fuses in the compartment- the one in use and a spare. The fuse further inside the compartment is active. The one closer to the compartment opening is the spare.

Replace the fuse with one with the exact rating of the original. The ERM-202 uses a 3A/250VAC fuse.



Figure 6 Fuse compartment



## Section 3.0                      Operation Instructions

### 3.1 Unpacking

Inspect ERM-202 for any physical damage due to shipping and transportation. Contact carrier if any damage is found. Check the packing list to see if any parts or accessories are missing.

#### Packing List

Item #	Description
1	ERM-202
2	Power cord
3	RS-232 cable (straight-wired)
4	USB cable
5	SR30 to BNC connection cable for analog outputs
6	User guide
7	Software cd

### 3.2 Front Panel Operation

1. Connect power cord and plug it into wall receptacle. Make sure the ground pin of the power cord is connected to earth ground.
2. Connect the device under test (DUT) to the ERM-202's input port(s). The FC adapter has a wide key slot on the top for flat (PC) connectors and a narrow key slot on the bottom for angled (APC) connectors. Make sure the optical power level at the input connector is below 10 dBm (10.0 mW).
3. Turn on the ER meter. It will begin automatic measurement using the default or previously specified settings. To change selectable operation settings, see items under the FUNCTIONS menu, as well as the SPEED and CYCLE settings (for ERM-202-1).



## 3.3 Measurement Modes

The ERM-202 has four measurement modes, as well as store/recall and setup functions. In all measurement modes, a dual channel ER meter displays the measured PER for channels 1 and 2 on the left side of the screen. Depending on the selected mode, the right side of the screen displays the measured power for each channel (this is the default mode), the power ratio between channels 1 and 2, the angle of the major axis of the polarization ellipse (relative to a reference angle) for each channel, or the estimated DOP for channels 1 and 2. The ENTER key is used to cycle through the available measurement modes.

### PER/Power

The default operation mode for the ERM-202 is automatic measurement. When the instrument is turned on, it executes an initialization process, and then measures and displays the real-time polarization extinction ratio (ER, in units of dB) and optical power (PWR, in units of mW or  $\mu$ W), using the default measurement speed of 0.4s/cycle. The single-channel version also displays the polarization angle  $\theta$ , in degrees, relative to the reference angle  $\theta_r$ . The default reference angle  $0.00^\circ$  corresponds to the vertical direction. Both  $\theta$  and  $\theta_r$  are in the  $-90$  to  $+90^\circ$  range.

1	XX.XX	ER dB	XX.XX	PWR mW	ER: 24.83 dB $\theta$ : 85.26
2	XX.XX	ER dB	XX.XX	PWR mW	
					P: 0.502 mw $\theta_r$ : 0.00

*ERM-202-2*

*ERM-202-1*

The STOP or STOP 1 and STOP 2 buttons stop the measurement processes for the corresponding channels. The latest set of measured values will remain on the display. If only one channel is subsequently started again, only that channel's data will be updated.

### Two-Input Power Ratio Measurement (ERM-202-2 only) for PM coupler characterization

Press the ENTER key once from the default measurement mode to bring up the Two-Input Power Ratio function. The left side of the screen continues to show the PER measurements for channels 1 and 2, while the right side of the screen shows the coupling ratio of the PM coupler under test on top and the power split ratio on the bottom:



1	XX.XX	ER dB	XX.XX	$\frac{P1}{P1 + P2} \%$
2	XX.XX	ER dB	XX.XX	P1/P2

ER: Instantaneous ER value calculated from the maximum and minimum power measured in the last polarizer rotation cycle.  $ER = 10 \cdot \log (P_{max}/P_{min})$

P1/(P1+P2): Coupling ratio of PM coupler under test, in %.

P1/P2: Power split ratio between channels 1 and 2.

### ER Maximum/Minimum Search Mode (ERM-202-1 only)

The ER meter’s automatic measurement mode correctly characterizes the worst-case ER of a DUT using a broadband source. However, if a narrow-band laser source is used to measure the ER of PM fiber, the instantaneous measured ER is not necessarily the worst-case (minimum) ER. To measure the ER of a PM fiber with a narrow-band laser source, the fiber can be either mechanically manipulated (stretched, bent, or moved) or temperature cycled. Either method will cause variation in the instantaneous ER, allowing the worst-case value to be found. Temperature cycling is the preferred method.

To facilitate this measurement, the ERM-202-1 has a maximum/minimum ER search function. From auto mode, press ENTER once to access the maximum/minimum ER search function.

ER: 20.45 dB  
MAX: 22.68 MIN: 18.60

ER: Instantaneous ER value calculated from the maximum and minimum power measured in the last polarizer rotation cycle.  $ER = 10 \cdot \log (P_{max}/P_{min})$

Max: Maximum ER value measured within the current measurement period

Min: Minimum ER value measured within the current measurement period

The measurement period begins when the max/min search mode is entered. To perform an ER measurement using a narrow-band source, first connect the source → PM fiber under test → ER meter. Put the ER meter into max/min search mode and either stretch or heat/cool the PM fiber. The MIN value measured will be the worst-case ER.

To reset the measurement period, use the ENTER key to cycle through measurement modes back to max/min mode.



## Angle Measurement Mode (ERM-202-2 only)

In the ERM-202-2, this mode displays the measured PER and polarization angle for channels 1 and 2. In the ERM-202-1, this function is included in the PER/Power mode described earlier, which displays PER, polarization angle, and power.

Press ENTER once from the two-input power ratio measurement screen to begin the Angle Measurement function.

1	XX.XX	ER dB	XX.XX	θ
2	XX.XX	ER dB	XX.XX	θ

ER: Instantaneous PER value calculated from the maximum and minimum power reading from the last polarizer rotation cycle.  $ER = 10 \cdot \log(P_{\max}/P_{\min})$

θ: Polarizer angle corresponding to the maximum power reading from the last polarizer rotation cycle, measured relative to the reference angle. The default reference angle is 0°, defined as the vertical direction. Polarization angle θ and reference angle θ<sub>r</sub> are measured in degrees, and will always be between -90° and +90°. See FUNCTIONS section for information on setting the reference angle to a value other than 0°.

## DOP Estimation Mode

For partially polarized light, the DOP can be estimated from the ER measurement using the following formula:

$$DOP = \frac{P_{\max} - P_{\min}}{P_{\max} + P_{\min}} = \frac{10^{\frac{ER_{\max}}{10}} - 1}{10^{\frac{ER_{\max}}{10}} + 1}$$

where ER<sub>max</sub> is the maximum ER value achievable by stretching/bending/moving the fiber or by temperature cycling the fiber. Temperature cycling is the preferred method.

Press ENTER once from the angle measurement mode (ERM-202-2) or the ER max/min search mode (ERM-202-1) to begin the DOP estimation function. The display will show:



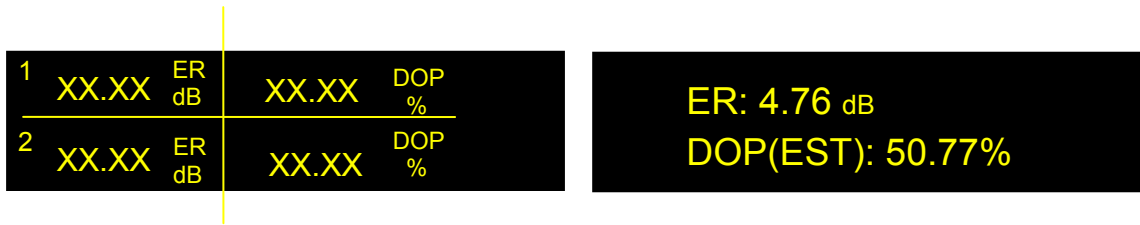

*ERM-202-2*

*ERM-202-1*

ER: Instantaneous ER value calculated from the maximum and minimum power reading from the last polarizer rotation cycle.  $ER = 10 \cdot \log(P_{\max}/P_{\min})$

DOP: Estimated DOP, calculated from  $DOP = [(10^{ER/10}-1)/(10^{ER/10}+1)] * 100$

Press ENTER once from DOP estimation mode to return the ER meter to the default automatic measurement mode.

### Manual Polarizer Control Mode (ERM-202-1 only)

This function is used for manual alignment control. The polarizer rotation angle is manually controlled from the front panel, with the power ratio measured at each step. Please note that the angle display in manual mode is for estimation purposes only and should not be taken as a precise angle measurement.

To enter manual control mode, press the MANUAL button.

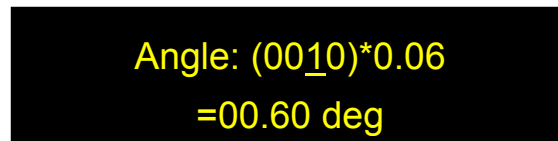

The minimum angle step size is 0.06°. Use the arrow keys to set the step size for the rotation angle by changing the multiplier. The left and right arrows change the active (underlined) digit, and the up and down keys increment the active digit. The step size range is 0.06° to 90° (multiplier range is 1 to 1500).

After setting the step size, press the ENTER key to execute the selection. The first time this is done after entering manual mode, the ER meter goes through an initialization step: a minimum power measurement is taken, then the polarizer is rotated to the vertical position (0° if  $\theta$  is 0°) and the display shows the manual measurement display screen:



PR: 10.05 dB     $\theta$ : 0.00  
P: 0.239 mW     $\theta_r$ : 0.00

In manual measurement mode,  $\theta$  is the current polarizer angle, measured relative to reference value  $\theta_r$ , P is the measured power at the current polarizer angle, and PR is the power ratio, in dB, between the measured power at the current polarizer angle and the minimum power measured during the manual mode initialization step.

From this point, each time ENTER is pressed, the polarizer will rotate one angle step from the current position, and the new measurement parameters will be displayed. The optical power will be automatically scaled to display in mW or  $\mu$ W.

Once in manual mode, the MANUAL button can be used to change the rotation step size without reinitializing the measurement. Pressing the ENTER key after the step size is changed will then cause the polarizer to rotate by the new step size from the current position.

### 3.4 Additional Features

This section describes functions for external ER monitoring, data storage/recall, and operational parameter setup.

#### Analog Monitor Voltage

The ERM-202 has analog monitor voltage outputs for all channels from the SR30 4-pin connector on the rear panel. General Photonics provides a conversion cable to BNC connectors.

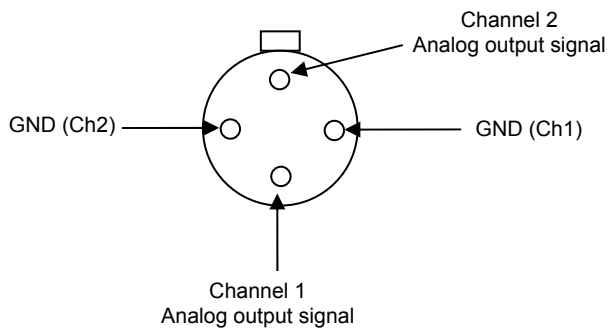
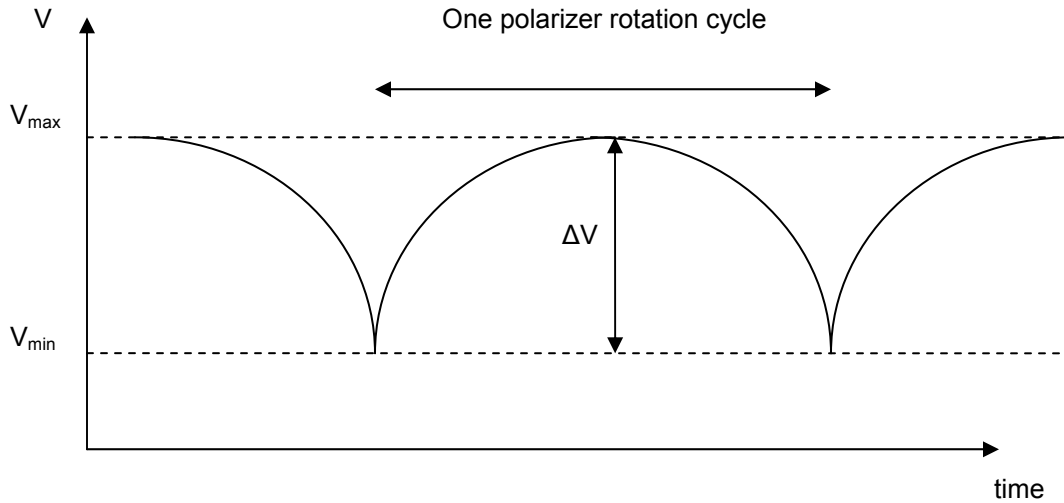

Figure 7 Analog output connector pinout (left), SR30 to BNC connection cable (right)



The monitor voltage scales with the log of the measured power after the polarizer. The PER can therefore be calculated from the difference between the maximum and minimum voltages measured over one polarizer rotation cycle. This voltage difference is linearly related to the measured PER (in dB) by the following equation:

$$ER = \Delta V/s$$

where

$$\Delta V = V_{\max} - V_{\min}, \text{ measured over one polarizer rotation cycle}$$

$$s = 0.04 \text{ is a scaling factor}$$

For example, if  $\Delta V = 1 \text{ V}$  and  $s = 0.04$ , then  $ER = 1/0.04 = 25 \text{ dB}$ .

## Data Storage and Recall

### Data storage:

Data from any automatic or manual measurement can be stored in the ER meter's memory. To store current measurement results, press STOP (for all channels currently in operation) to stop measurement, then press STORE. The data stored in each measurement mode is as follows:

ERM-202-2:

Measurement mode	Data stored
PER/Power mode	ER1, power1, ER2, power2
Two-Input Power ratio	ER1, $P1/(P1+P2)$ , ER2, $P1/P2$
Angle measurement	ER1, $\theta1$ , ER2, $\theta2$
DOP estimation mode	ER1, DOP1, ER2, DOP2

## ERM-202 User Guide

ERM-202-1:

Measurement mode	Data stored
Default auto mode	ER, power, angle, reference angle
Max/Min ER mode	ER, ER max, ER min
DOP estimation mode	ER, DOP
Manual mode	Power ratio, power, current polarizer angle, reference angle

The display will show:



Store ID: 01

Use the UP/DOWN keys ( $\blacktriangle$ / $\blacktriangledown$ ) to select the desired storage location. There are 100 storage locations (#0-99) available. The ENTER key stores the data to the selected storage location and restarts automatic measurement.

### Data retrieval:

To retrieve stored data, press RECALL. The display will show:



Recall ID: 01

Use the up and down arrow keys to select the desired storage location. Pressing ENTER will display the data stored in that location. If there is no information stored at the selected location, the display will show a "No Data" message.

Press RECALL again to return to recall ID selection.

### Setup Parameters

The FUNC key allows the user to access and set various operational parameters. Pressing the FUNC key brings up a set of menus:

## ERM-202 User Guide

ERM-202-2

1. GPIB Address 2. Wavelength	↓
3. Connector Type 4. Speed	↑ ↓
5. Standby Time 6. Average Cycles	↑ ↓
7. Reference Angle1 8. Reference Angle2	↑ ↓
9. Get Dynamic IP 10. Static IP	↑

ERM-202-1

1. GPIB Address 2. Wavelength	↓
3. Connector Type 4. Standby Time	↑ ↓
5. Reference Angle 6. Get Dynamic IP	↑ ↓
7. Static IP	↑

Use the UP/DOWN (▲▼) arrow keys to move between menu options and the ENTER key to select the one indicated by the hand pointer. Up and down arrows on the right side of the display screen indicate whether additional menu options can be accessed by scrolling up or down. Most of these parameter settings are written to memory and retained after power-down.

### GPIB Address:

To change the GPIB address, press the FUNC key and select "1. GPIB Address".

GPIB ADDR: 05

Use the UP/DOWN arrow keys (▲▼) to change the address. The address range is 1 to 30. Press ENTER to save the setting.

### Wavelength:

The ER meter is calibrated at two typical wavelengths. For the 1260-1620nm version, these are 1310 nm and 1550 nm (calibration at other wavelengths is available).

## ERM-202 User Guide

To change the calibrated wavelength setting, press the FUNC key and select "2. Wavelength".

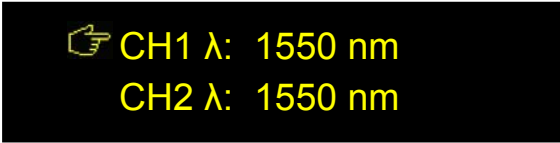

CH1  $\lambda$ : 1550 nm  
CH2  $\lambda$ : 1550 nm

ERM-202-2



Wavelength Select  
1550 nm

ERM-202-1

ERM-202-2: Use the LEFT/RIGHT arrow keys ( $\blacktriangleleft$ / $\blacktriangleright$ ) to move between channel selection and wavelength selection for a particular channel (the wavelength will be underlined). Use the UP/DOWN arrow keys ( $\blacktriangle$ / $\blacktriangledown$ ) to select a channel or change the wavelength.

ERM-202-1: Use the UP/DOWN arrow keys ( $\blacktriangle$ / $\blacktriangledown$ ) to change the wavelength.

Press ENTER to execute the new settings. The instrument will begin measurement using the new wavelength settings.

### Connector type:

The ER meter can accept both flat (PC, upper key slot) and angle polished (APC, lower key slot) optical connectors, and is set for PC by default.

Press FUNC and select "3. Connector Type".

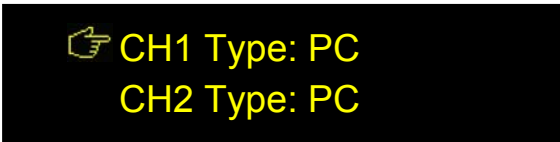

CH1 Type: PC  
CH2 Type: PC

ERM-202-2



Connector Type  
PC

ERM-202-1

ERM-202-2: Use the LEFT/RIGHT arrow keys ( $\blacktriangleleft$ / $\blacktriangleright$ ) to move between channel selection and connector type selection for a particular channel (the connector type will be underlined). Use the UP/DOWN arrow keys ( $\blacktriangle$ / $\blacktriangledown$ ) to select a channel or change the connector type.

ERM-202-1: Use the UP/DOWN arrow keys ( $\blacktriangle$ / $\blacktriangledown$ ) to change the connector type.

Press the ENTER key to execute the new settings.

### Measurement speed:

The default measurement speed is 0.4s per polarizer rotation cycle.

ERM-202-2: Press the FUNC button and select "4. Speed".

ERM-202-1: Press the SPEED button.



SPEED: 0.4s

## ERM-202 User Guide

Use the up and down arrow keys to change measurement speeds. The available measurement speeds are: 0.1, 0.2, 0.4, and 1 s/cycle. A 10s/cycle speed is also available on the ERM-202-1. The ENTER key applies the selected speed setting for both measurement channels and resumes automatic measurement.

The measurement speed setting is not saved after power-down. It will reset to 0.4s/cycle the next time the ER meter is powered on.

### **Standby:**

The ER meter will go into standby mode after a designated period with no user interaction. The display will show:

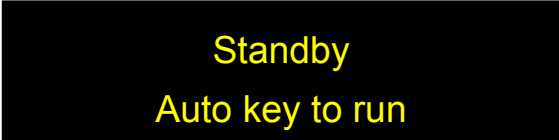

Standby  
Auto key to run

Press one of the AUTO keys or send a START remote control command to exit standby and restart automatic measurement.

The ER meter's factory default standby timer setting is  $\infty$  (no standby). To change it, press the FUNC button and select "Standby Time".



Time: 10 min

The standby time can be set to 5 (ERM-202-2 only), 10, 15, 20, 25, 30 and  $\infty$  minutes. Press the ENTER key to restart automatic measurement with the new standby time setting.

For continuous operation, the user can disable the standby function by setting the standby time to  $\infty$ . However, leaving the ER meter running when it is not in use is not recommended.

### **Rotation cycles:**

The ER meter averages over a designated number of polarizer rotation cycles to generate each set of data. The default setting is 1 cycle (no averaging).

ERM-202-2: Press the FUNC button and select "6. Average Cycles".

ERM-202-1: Press the CYCLE button.



Cycle: 1

Use the up and down arrow keys to set the number of cycles. The range is 1 to 10 cycles. The ENTER key restarts automatic measurement using the new averaging setting.

### Reference Angle:

To set the reference angles used for angle measurement, press the FUNC button.

ERM-202-2: Select "7. Reference Angle1" to reset the reference angle for channel 1 or "8. Reference Angle2" to reset the reference angle for channel 2.

ERM-202-1: Select "5. Reference Angle".

*ERM-202-2*

CH1  $\theta_r$ : +00.00

*ERM-202-1*

$\theta_r$ : +00.00

Or

CH2  $\theta_r$ : +00.00

Use the LEFT/RIGHT arrow keys ( $\blacktriangleleft$ / $\blacktriangleright$ ) to change the active (underlined) digit, and the UP/DOWN keys ( $\blacktriangleup$ / $\blacktriangledown$ ) to increment the active digit. After ENTER is pressed, automatic measurement will resume, and the display will show the measurement results with  $\theta$  measured relative to the new reference angle. Reference angle range is  $\pm 90^\circ$ . The default value is  $0^\circ$ , which corresponds to a vertical polarizer orientation (aligned with the connector keys).

### Ethernet IP address:

The instrument's IP address must be known in order to control it via Ethernet.

See Appendix for Ethernet setup details.

To set the Ethernet IP address, press the FUNC button and select "Get Dynamic IP" or "Static IP".

### Dynamic IP

Selecting "Get Dynamic IP" requests a dynamic IP address from the server.

Getting Dynamic IP..  
(Please Wait)

If the instrument is able to establish communication with the DHCP server and successfully retrieve an IP address, the address will be displayed on-screen.

Dynamic IP Address  
192.168.2.150

If the instrument is unable to connect to the server, it may display 0.0.0.0. In this case, check the connection.

Each time this menu option is selected, the instrument requests a dynamic IP address from the server. If this menu option is selected while the instrument is already in communication using a dynamic IP address, the instrument may be assigned a dynamic IP address other than the one it is currently using. This may interrupt communication, and the address may not be displayed correctly on the front panel.

**Static IP**

Selecting "Static IP" sets the instrument for Ethernet communication using static IP addressing and allows the user to set the static IP address, Net Mask, Gateway, Name Server, and Port. The setup screens for this option are as follows:

Static IP Address ↓  
a. 192.168.002.150

Netmask ↑  
b. 255.255.255.000 ↓

Gateway ↑  
c. 192.168.002.001 ↓

Nameserver ↑  
d. 192.168.002.001 ↓

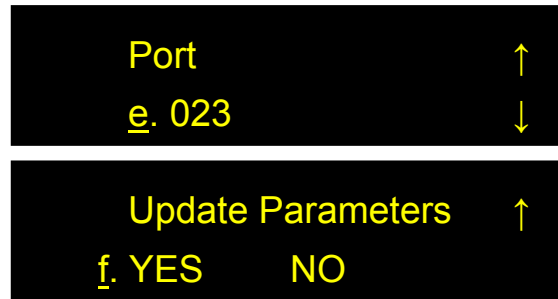

Use the UP/DOWN arrow keys (▲▼) to move between static IP setup parameter options when the cursor is on the setup parameter index (a-f).

Press the ► key to move to setup for the currently selected parameter.

Use the LEFT/RIGHT arrow keys (◀▶) to move the cursor position, and the UP/DOWN keys (▲▼) to increment the active digit. The ENTER key returns the cursor to the index selection position. When all of the static IP parameters are set, select "YES" on the "Update Parameters" screen (index f) and press the ENTER key to apply the setting. The front panel display will show:

The image shows a black rectangular box with yellow text that reads 'Updating Static IP' on the top line and '(Please Wait)' on the bottom line.

When the update is finished, automatic measurement will resume, and the display will return to the function menu screen (ERM-202-2) or the default measurement screen (ERM-202-1).

If "NO" is selected on the "Update Parameters" screen, the display will return to the function menu screen without updating the parameters (ERM-202-2) or to screen "a"- static IP address setup (ERM-202-1).

The default port setting is 23. In most cases, this does not need to be changed.
--



## 3.5 Troubleshooting

The performance of the ERM-202 can be tested using light sources and/or components with known characteristics.

### Front Panel

1. The accuracy of the measured ER will decrease if the input optical power is too low.
2. Large and/or fast power fluctuations can render the ER reading unstable. If the ER reading varies significantly, check the stability of the optical source.
3. To ensure an accurate reading, make sure that the ER meter is on a stable surface and does not move during measurement.
4. For standard automatic measurement, use a broadband source. A narrow band source can be used with the ER max/min function of the ERM-202-1.

### Remote Control

#### **Command Format**

1. If the beginning ("\*") or ending identifiers ("#" or "?") of a command are missing, the instrument will not respond.
2. Errors may occur during communication due to hardware control (measurement interruptions). The typical response from the instrument in this case is E01. If this occurs, the user should resend the command until the correct response is received.
3. Communication may occasionally freeze (overflow) due to port conflict (more common during ETHERNET control). In this case, the user may need to restart the ERM-202 to re-enable remote control.

#### **RS-232**

1. Make sure that the cable is straight-wired (pin-to-to pin wired) not cross-wired.
2. Verify active Comm Port (COM1, COM2, etc.).
3. Verify Comm Port settings: 8 data bits, 1 stop bit, no parity bits.
4. Check baud rate: 9600 bps by default.



**Section 4.0 Specifications**

**Optical**

Operating wavelength range <sup>1</sup>	1260-1620 nm	960-1160nm
Calibrated operating wavelengths <sup>2</sup>	1310nm, 1550nm	980nm, 1064nm
PER dynamic range	>50 dB	>40 dB
PER ranges <sup>3</sup>	0-50 dB (input power -5 to +10 dBm) 0-30 dB (input power -25 to -5 dBm)	0-40 dB (input power 0 to +10 dBm) 0-30 dB (input power -20 to 0 dBm)
Input optical power range	-30 to 10 dBm	-20 to 10 dBm
PER resolution	0.1 dB	
PER accuracy <sup>3</sup>	±0.15 dB for ER <30 dB	
Angular resolution	0.06°	
Angular accuracy	± 1°	
Optical power resolution	0.02 dBm (PER < 30) 0.2 dBm (PER > 30)	
Power measurement accuracy	± 0.5 dB	
Power resolution	0.02 dB (PER < 30 dB), 0.2 dB (PER > 30 dB)	
Optical power damage threshold	300 mW	
Measurement speed	0.1, 0.2, 0.4, 1 sec/cycle (both versions) 10s/cycle, manual control (single channel only)	

**Electrical**

Front panel display	OLED graphic display
Power Supply	100-240VAC, 50-60 Hz
Analog Output	0-5V (max range) monitor voltage scales with log of measured power after polarizer. Range can be <5V.
Communication Interfaces	RS-232, USB, Ethernet, GPIB

**Physical and Environmental**

Dimensions <sup>4</sup>	Standard 2U half-19" rack mount size 14" (L) × 8.5" (W) × 3.5" (H)	
Input Fiber Type	PM or single mode fiber	
Fiber Input Adapter <sup>1, 5</sup>	FC	
Weight	Dual channel	6.25 lb
	Single channel	6 lb
Operation temperature	0 to 40°C	
Storage Temperature	-20 to 60°C	

**Notes:**

Specifications listed in table apply for operation at 23±5°C.

1. Other wavelength ranges and connector types may be available.

## ERM-202 User Guide

2. Other calibrated wavelengths available upon request.
3. For measurement speeds 0.4s/cycle or slower.
4. Rack mount kit available. Contact General Photonics for details.
5. Free space adapter for FC connectors accepts either flat or angle polished fiber connectors.



## Appendices

General Photonics provides a test program for remote control of the ERM-202. The control software is included on the accompanying cd. The following appendices include the remote control command lists, setup for different control interfaces, and installation and application procedures for the control software.

### Appendix 1.0 Remote Control Commands

The commands and responses listed in Table 1, Table 2, and Table 3 are the same for all communication protocols: RS-232, USB, Ethernet, and GPIB.

Once the ERM-202 receives a command, it goes into remote control mode, and the front panel keypad is locked. A small R will appear on the screen. Press LOCAL (ERM-202-2) or ENTER (ERM-202-1) to return to front panel control.

#### Command Lists

**Table 1 Command list: ERM-202-2**

System Commands												
Command	Description	Response										
*IDN?	Queries the instrument product number.	*IDN GP ERM-202D V1.4 SN:203210000268# Else *Enn#. See Table 3 for error codes										
*VER?	Queries the Firmware Version	*VER V1.4 20150430# (Version Dependent )										
*RST#	Reset all operation parameters to default values.	*E00# if successful. Else *Enn#. See Table 3 for error codes										
*SAV nn#	Save the data currently shown on the front panel to location nn; Range for nn: 00 to 99 Example: *SAV 9# (save to location 9)	*E00# if successful. Else *Enn#. See Table 3 for error codes										
*RCL nn#	Recalls the data from storage location nn and displays it on the front panel; Range for nn: 00 to 99 Response begins with display mode label: <table style="font-size: small; margin-left: 20px;"> <tr> <td>Display-Mode</td> <td>Mode #</td> </tr> <tr> <td>ER/Pwr</td> <td>1</td> </tr> <tr> <td>ER power ratio</td> <td>2</td> </tr> <tr> <td>ER/Angle</td> <td>3</td> </tr> <tr> <td>DOP</td> <td>4</td> </tr> </table>	Display-Mode	Mode #	ER/Pwr	1	ER power ratio	2	ER/Angle	3	DOP	4	Example:*RCL 9# (Recall data from location 9) Response Formats: *1, ER1, power1, ER2, power2# *2, ER1, P1/(P1+P2), ER2, P1/P2# *3, ER1, 01, ER2, 02# *4, ER1, DOP1, ER2, DOP2# Else *Enn#. See Table 3 for error codes
Display-Mode	Mode #											
ER/Pwr	1											
ER power ratio	2											
ER/Angle	3											
DOP	4											
*ADR?	Query instrument GPIB address. Value stored in non-volatile memory. Range 1 – 30.	*ADR xx# for GPIB address xx Else *Enn# see Table 3 for error codes										
*ADR nn#	Set the GPIB address to nn. Range 1 – 30.	*E00# if successful. Else *Enn# see Table 3 for error codes										
*STP#	Stop polarizer rotation for both channels	*E00# if successful. Else *Enn# see Table 3 for error codes										
*STP 1# *STP 2#	Stop polarizer rotation for channel 1 or channel 2, respectively.	*E00# if successful. Else *Enn# see Table 3 for error codes										
*STT#	Used after a *STP# command. Resume a stopped measurement of both channels in the mode the instrument was in before the *STP# command was executed.	*E00# if successful. Else *Enn# see Table 3 for error codes										
*STT 1# *STT 2#	Used after a *STP# command. Resume a stopped measurement of Channel 1 or Channel 2, respectively.	*E00# if successful. Else *Enn# see Table 3 for error codes										

## ERM-202 User Guide

*SPD n#	Set polarizer rotation speed. There are four options for the time needed for 1 full polarizer rotation cycle: 0.1/ 0.2/0.4/1.0s Default setting is 0.4s/cycle	Example: *SPD 0.4# Response *E00# if successful. Else *Enn# see Table 3 for error codes
*SPD?	Query the current polarizer speed setting. Range 0.1s to 1s (see *SPD n#)	Example: *SPD 0.2# Current setting is option 0.2s/cycle
*IND ON# *IND OFF#	Enable/disable inclusion of parameter labels in responses to data queries. Default value: ON	Example: When indicators are ON, response to a wavelength query is *WAV 1550# When OFF, response is *1550#
*TYP 1 sss# *TYP 2 sss#	Set the connector type of channel 1 and channel 2, respectively. Connector options are: <b>APC:</b> Angled Physical Contact connector or <b>PC:</b> Physical Contact (flat) connector	Example: *TYP 1 APC# to set Channel 1 as APC connector. Response *E00# if successful. Else *Enn# see Table 3 for error codes
*TYP 1? *TYP 2?	Query the connector type settings of Channel 1 and Channel 2, respectively.	Response: *TYP1 APC# or: *TYP1 PC# Else *Enn# see Table 3 for error codes
*TIM nn#	Set the standby time (period after which the ERM-202 goes into standby if there is no user interaction). nn = 5/10/15/20/25/30(min), or 00 (standby disabled).	Example: *TIM 25#
*TIM?	Query the set standby time (period after which the ERM-202 goes into standby if there is no user interaction).	Response Example: *TIM 25# Else *Enn# see Table 3 for error codes
<b>Measurement data queries and optical parameter setting</b>		
Command	Description	Response
*POW 1? *POW 2?	Query measured optical power. Response includes units (mW, $\mu$ W, etc). If this command is sent from a mode other than auto measurement mode, the ER meter will go into auto mode.	Example: *POW 1 1.35451mw#, Else *Enn# see Table 3 for error codes
*PER 1? *PER 2?	Query PER of channel 1 or 2, respectively. Result given in dB	Response Example: *PER1 15.81# Else *Enn# see Table 3 for error codes
*ANG 1? *ANG 2?	Query the measured polarization angle of channel 1 or channel 2, respectively, relative to the reference angle. Result given in degrees.	Response Example: * ANG1 2.50# Else *Enn# see Table 3 for error codes
*REF 1 snn.nn# *REF 2 snn.nn#	Set the reference angle of channel 1 or 2: $-90.00^\circ < \text{angle} < 90.00^\circ$ "s" indicates + or - sign. + sign is optional for positive angles.	Example: *REF -27.56# Response *E00# if successful. Else *Enn# see Table 3 for error codes
*REF 1? *REF 2?	Query the reference angle of channel 1 or 2. $-90.00^\circ < \text{angle} < 90.00^\circ$	Response Example: *REF 1 -27.56# Else *Enn# see Table 3 for error codes
* CPR?	Queries the coupling ratio, defined as $P1/(P1+P2)*100\%$ , where P1 and P2 are the input powers of channels 1 and 2, respectively.	Response format: *CPR ff.f# Example: *CPR 15.9# Ch1 coupling ratio is 15.9%
* PSR?	Queries the power split ratio, defined as $P1/P2$ , where P1 and P2 are the input powers of channels 1 and 2, respectively.	Example: *PSR 9.0#
*DOP 1? *DOP 2?	Query the estimated DOP value of channel 1 or 2, respectively. ER meter must be in DOP estimation mode to respond correctly.	Response format: DOP 1 99.9# Else *Enn# see Table 3 for error codes
*WAV 1? *WAV 2?	Query operation wavelength setting of channel 1 or 2, in nm.	Response example: *WAV 1 1550# or *WAV 2 1310#
*WAV 1 nnnn# *WAV 2 nnnn#	Set operation wavelength (nm) Options: 1550 and 1310 ONLY for standard configuration ERM-202 (other wavelengths can be specially requested when ordering)	Example: *WAV 1 1550# Response: *E00# if successful. Else *Enn# see Table 3 for error codes

Note: When sending a data query command, make sure that the ER meter is in the corresponding measurement mode. For example, it should be in DOP estimation mode (code ED) before the \*DOP? Command is sent.

## ERM-202 User Guide

Operation Mode Commands		
Command	Description	Response
*MOD?	Query the measurement mode. Possible responses are: *MOD EP# PER and optical power measurement *MOD EA# PER and polarization angle measurement *MOD ED# PER & DOP estimation *MOD EC# PER, coupling ratio, and power split ratio between inputs of the two channels *MOD FN# Display Other Function. *MOD RE# Recall mode	Responses listed at left Else *Enn# see Table 3 for error codes
*MOD ss#	Set the measurement mode to ss and start measurement. ss options: EP: PER& PWR measurement EA: PER & Angle measurement ED: PER & DOP estimation EC: PER, coupling ratio and power split ratio	*E00# if successful, Else *Enn# see Table 3 for error codes
*MIN:RST#	Initialize Minimum and Maximum values.	*E00# if successful, Else *Enn# see Table 3 for error codes
*CYC?	Query the number of polarizer rotation cycles used for averaging for each measurement.	Response Format: *CYC nn# Example: *CYC 5#
*CYC nn#	Set the number of cycles used for averaging for each measurement. Range for nn is 1-10	*E00# if successful, Else *Enn# see Table 3 for error codes

**Table 2 Command list: ERM-202-1**

System Commands		
Command	Description	Response
*IDN?	Queries the instrument product number	*IDN GP ERM-202S V1.4 SN:203210000242# Else *Enn# see Table 3 for error codes
*VER?	Queries the Firmware Version	*VER V1.4-S 20150420# (Version Dependent )
*RST#	Reset all operation parameters to default values.	*E00# if successful. Else *Enn# see Table 3 for error codes
*SAV nn#	Save the data currently shown on the front panel to location nn; Range for nn: 00 to 99 Example: *SAV 9# (save to location 9)	*E00# if successful. Else *Enn# see Table 3 for error codes
*RCL nn#	Recalls the data from storage location nn and displays it on the front panel; Range for nn: 00 to 99 Response begins with display mode label: <u>Display-Mode    Mode #</u> ER/Pwr/Ang    1 ER Max /Min    2 DOP            3 Manual         4	Example:*RCL 9# (Recall data from location 9) Response Formats: *1,ER, PWR, ANG, REF# *2,ER, ERmax ,ERmin# *3,ER, DOP# *4,PR, PWR,ANG,REF# Else *Enn# see Table 3 for error codes
*ADR?	Query instrument GPIB address. Value stored in non-volatile memory. Range 1 – 30.	*ADR xx# for GPIB address xx Else *Enn# see Table 3 for error codes
*ADR nn#	Set the GPIB address to nn. Range 1 – 30.	*E00# if successful. Else *Enn# see Table 3 for error codes
*STP#	Stop polarizer rotation	*E00# if successful. Else *Enn# see Table 3 for error codes
*STT#	Used after a *STP# command. Resume a stopped measurement in the mode the instrument was in before the *STP# command was executed.	*E00# if successful. Else *Enn# see Table 3 for error codes

## ERM-202 User Guide

*SPD n#	Set polarizer rotation speed. There are five options for the time needed for 1 full polarizer rotation cycle: 0.1/ 0.2/0.4/1.0/10s Default setting is 0.4s/cycle	Example: *SPD 0.4# Response *E00# if successful. Else *Enn# see Table 3 for error codes
*SPD?	Query the current polarizer speed setting. Range 0.1s to 10s (see *SPD n#)	Example: *SPD 0.2# Current setting is option 0.2s/cycle
*IND ON# *IND OFF#	Enable/disable inclusion of parameter labels in responses to data queries. Default value: ON	Example: When indicators are ON, response to a wavelength query is *WAV 1550# When OFF, response is *1550#
*TYP sss#	Set the connector type. Connector options are: <b>APC</b> : Angled Physical Contact connector or <b>PC</b> : Physical Contact (flat) connector	Example: *TYP APC# to set measurement for APC connector. Response *E00# if successful. Else *Enn# see Table 3 for error codes
*TYP?	Query the connector type setting.	Response: *TYP APC# or: *TYP PC# Else *Enn# see Table 3 for error codes
*TIM nn#	Set the standby time (period after which the ERM-202 goes into standby if there is no user interaction). nn = 10/15/20/25/30(min), or 00 (standby disabled).	Example: *TIM 25#
*TIM?	Query the set standby time (period after which the ERM-202 goes into standby if there is no user interaction).	Response Example: *TIM 25# Else *Enn# see Table 3 for error codes
<b>Measurement data queries and optical parameter setting</b>		
Command	Description	Response
*POW?	Query measured optical power. Response includes units (mW, $\mu$ W, etc). If this command is sent from a mode other than auto measurement mode, the ER meter will go into auto mode.	Example: *POW 1.35451mw#, Else *Enn# see Table 3 for error codes
*PER?	Query PER (in auto mode) or power ratio (in manual mode). Result given in dB	Response Example: *PER 15.81# Else *Enn# see Table 3 for error codes
*ANG?	Query the measured polarization angle (in auto mode) or the current polarizer rotation angle (in manual mode), relative to the reference angle. Result given in degrees.	Response Example: * ANG 2.50# Else *Enn# see Table 3 for error codes
*REF snn.nn#	Set the reference angle: $-90.00^\circ < \text{angle} < 90.00^\circ$ "s" indicates + or - sign. + sign is optional for positive angles.	Example: *REF -27.56# Response *E00# if successful. Else *Enn# see Table 3 for error codes
*REF?	Query the reference angle $-90.00^\circ < \text{angle} < 90.00^\circ$	Response Example: *REF -27.56# Else *Enn# see Table 3 for error codes
*PER MAX?	Query the maximum ER value recorded within the current measurement period. ER meter must be in maximum/minimum search mode to respond to this command.	Response Example: *PER MAX 5.81# Else *Enn# see Table 3 for error codes
*PER MIN?	Query the minimum ER value recorded within the current measurement period. ER meter must be in maximum/minimum search mode to respond to this command.	Response Example: *PER MIN 1.81# Else *Enn# see Table 3 for error codes
*DOP?	Query the estimated DOP value of the light source under test. ER meter must be in DOP estimation mode to respond correctly.	Response format: DOP 99.9# Else *Enn# see Table 3 for error codes
*WAV?	Query operation wavelength setting, in nm.	Response example: *WAV 1550#
*WAV nnnn#	Set operation wavelength (nm) Options: 1550 and 1310 ONLY for standard configuration ERM-202 (other wavelengths can be specially requested when ordering)	Example: *WAV 1550# Response: *E00# if successful. Else *Enn# see Table 3 for error codes

## ERM-202 User Guide

Note: When sending a data query command, make sure that the ER meter is in the corresponding measurement mode. For example, it should be in DOP estimation mode (code ED) before the \*DOP? Command is sent.

Operation Mode Commands		
Command	Description	Response
*MOD?	Query the measurement mode. Possible responses are: *MOD EP#: PER, PWR & Angle measurement *MOD EM# Max/Min PER measurement *MOD ED# PER & DOP estimation *MOD MS# Manual mode *MOD FN# Display Other Function	Responses listed at left Else *Enn# see Table 3 for error codes
*MOD ss#	Set the measurement mode to ss and start measurement. ss options: EP: PER, PWR & Angle measurement EM: Max/Min PER measurement ED: PER & DOP estimation MS: Manual mode	*E00# if successful, Else *Enn# see Table 3 for error codes
*MIN:RST#	Initialize Minimum and Maximum values.	*E00# if successful, Else *Enn#. See Else *Enn# see Table 3 for error codes
*CYC?	Query the number of polarizer rotation cycles used for averaging for each measurement.	Response Format: *CYC nn# Example: *CYC 5#
*CYC nn#	Set the number of cycles used for averaging for each measurement. Range for nn is 1-10	*E00# if successful, Else *Enn# see Table 3 for error codes
*MAN:ZEO#	Initialize Manual mode. Takes a minimum power measurement to be used for calculating power ratio during manual measurement, then rotates the polarizer to the 0° (vertical) position.	*E00# if successful. Else *Enn# see Table 3 for error codes
*MAN:STE?	Query the angle step size setting in manual mode. Result is given in terms of the unit angle multiple nnnn, where Step angle = (nnnn) * 0.06° Range for nnnn: 1-1500	Response Format: *STE nnnn# Example: *STE 100# For multiplier = 100 (step angle = 6°)
*MAN:STE nnnn#	Set the angle step size for manual mode in terms of the unit angle multiple nnnn, where Step angle = (nnnn) * 0.06° Range for nnnn is 1-1500	*E00# if successful, Else *Enn# see Table 3 for error codes
*MAN:STE#	Rotate the polarizer by one step, using the current step size setting. If this command is sent while the ERM-202 is in an operation mode other than manual mode, it will switch to manual mode.	*E00# if successful, Else *Enn# see Table 3 for error codes

**Table 3 Command Response Codes**

E00	No error (Correct command received)
E01	Undefined Command
E02	Missing parameter
E03	Invalid syntax found in command string
E04	String of characters too long (>buffer limit)
E05	Parameter has too many digits after the decimal point
E06	Parameter outside the allowed range
E07	Failed Self Test
E08	Power too high
E09	Power too low
E10	Incorrect operating wavelength (Outside the operating wavelength range)
E11	Error loading stored values
E12	Unable to store state



## Appendix 2.0 RS-232 connection and setup

1. The RS-232 connector on the rear panel of the ERM-202 is a DB9 male connector. Use a straight (not cross connected) RS-232 cable with DB9 female connectors to connect the ERM-202 to the control computer.

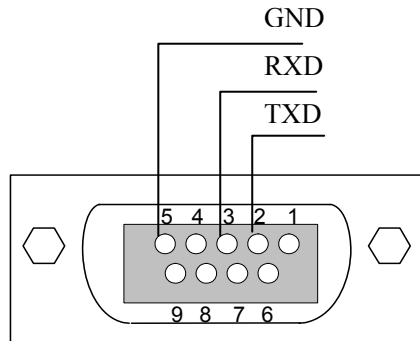

Figure 8 RS-232 connector pin assignment on ERM-202 rear panel.

2. Power on the instrument.
3. Send a command string to the ERM-202 (See Table 1 and Table 2 for commands. Any program that supports RS-232 communication protocols can be used to send ASCII commands to the instrument. Many programming languages support serial communications, including Visual Basic, LabView and C.

### RS-232 settings:

RS-232 port uses asynchronous framing, 8 data bits, no parity bit, and 1 stop bit.

RS-232 baud rate: 9600 bps.

Only one command is allowed in each command string.





## Appendix 3.0 USB connection and setup

USB drivers are included in the "VCP" folder on the cd. They need to be installed before USB communication can be established. The first time the USB is used, insert the cd into the control computer.

Connect the ERM-202 to the control computer using a standard USB cable.

Power on the ERM-202.

### USB Driver Installation

The first time the computer detects a USB connection to the instrument, the driver may install automatically (Windows 7 or 8) or a "Found New Hardware Wizard" window may appear (Windows XP). If neither of these things occur, the driver can be located and installed using Device Manager.

1. Open Device Manager. Look for "FT245R USB FIFO" under "Other Devices". Right-click it and select "Update Driver Software".

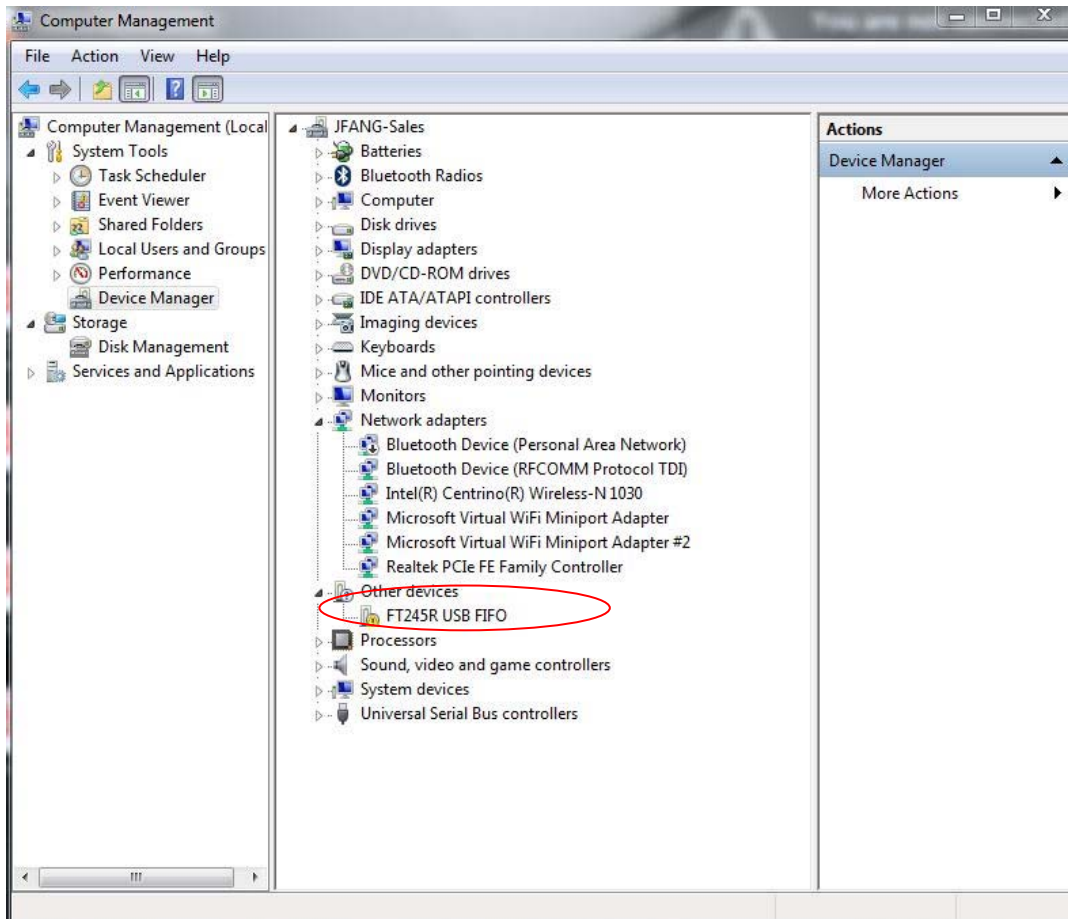

# ERM-202 User Guide

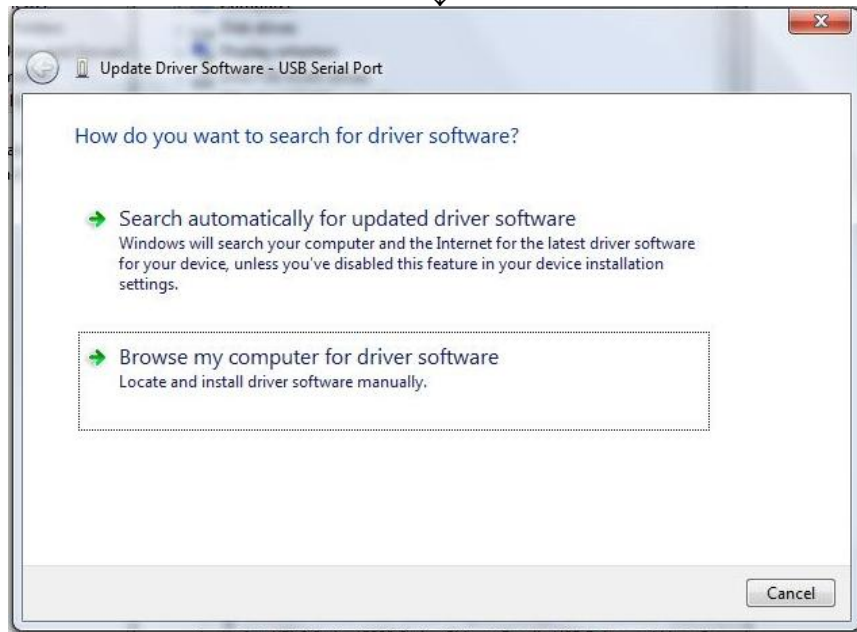
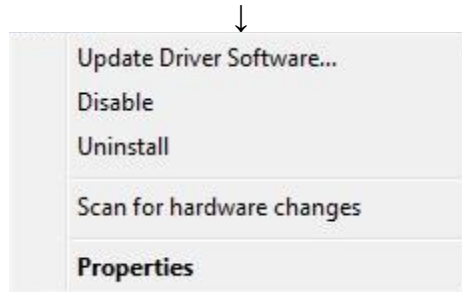

2. Select "Browse my computer for driver software":

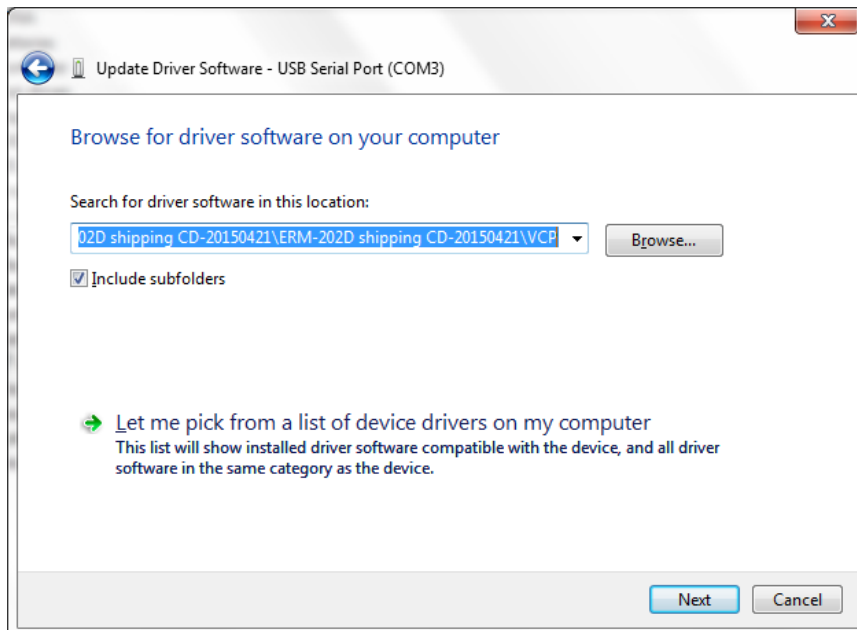

## ERM-202 User Guide

3. Make sure that the software cd is inserted. Click "Browse", navigate to the cd drive, and select the "VCP" folder. Make sure the "include subfolders" box is checked. Click "Next".



4. The computer will ask whether to install the software. Click "Install".



5. When the installation is finished, a "software successfully updated" message will appear. This completes the first part of the installation, during which the USB to serial converter is installed. The second part consists of the installation of the serial port driver.

## ERM-202 User Guide

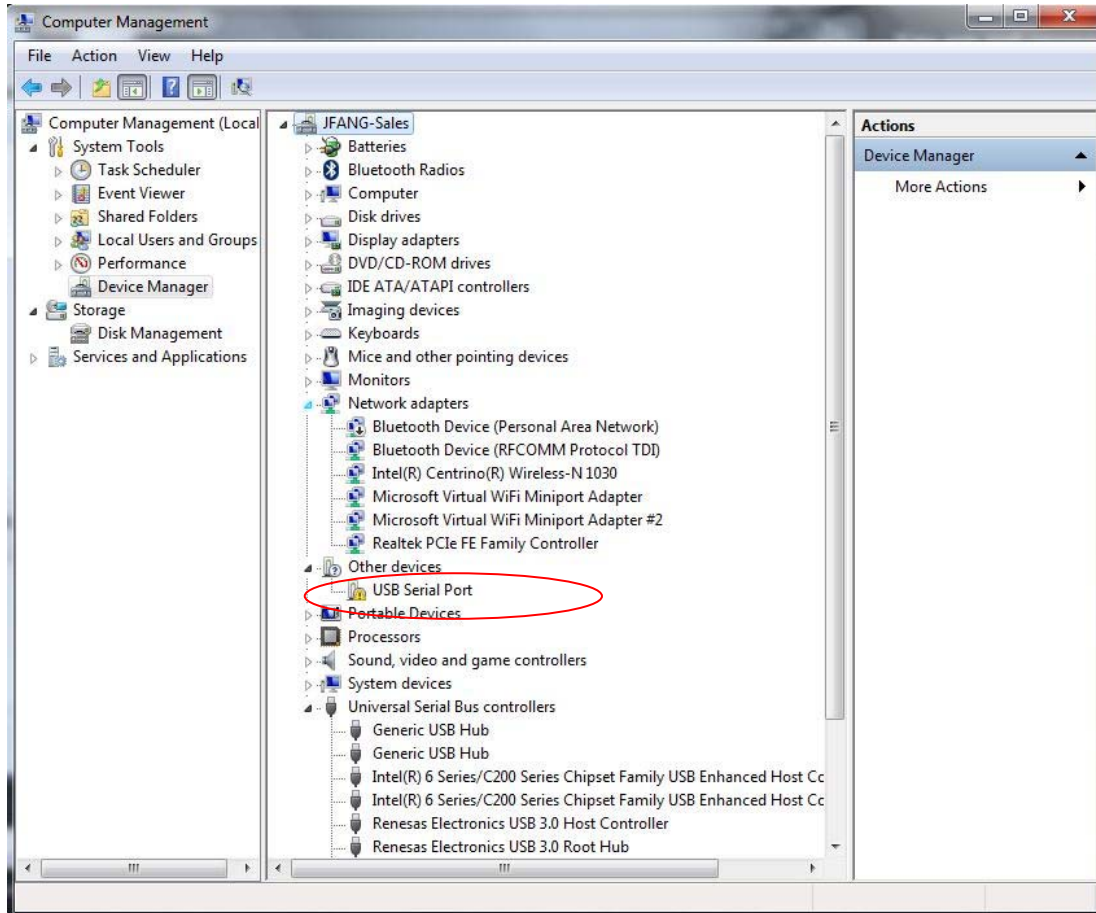

6. In Device Manager, "USB Serial Port" should now appear under "Other Devices. Right-click it and select "Update Driver Software". Follow the same procedure as described above to specify the driver location and install the driver until the completion window for the USB serial port appears:

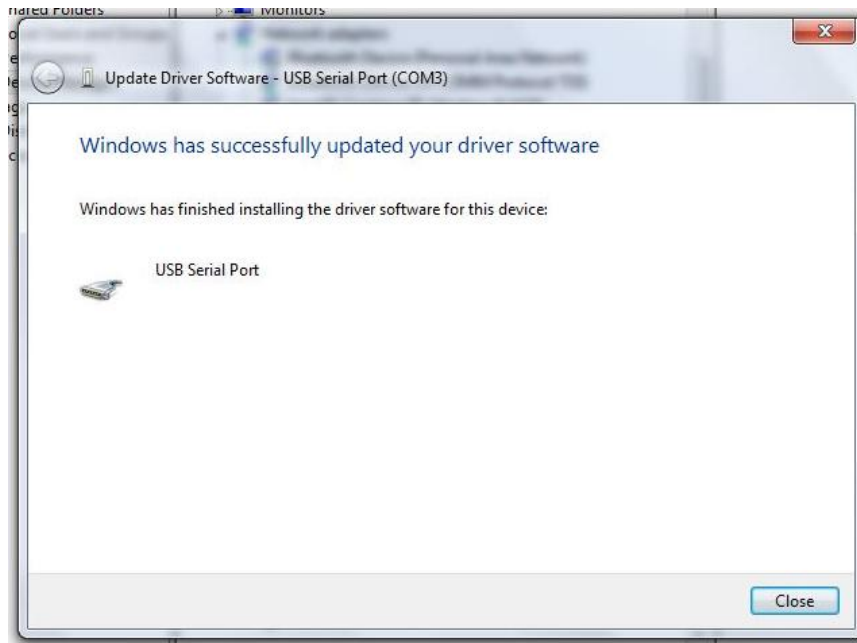

7. In "Device Manager", there should now be a USB Serial Port listed under "Ports (COM & LPT)":

## ERM-202 User Guide

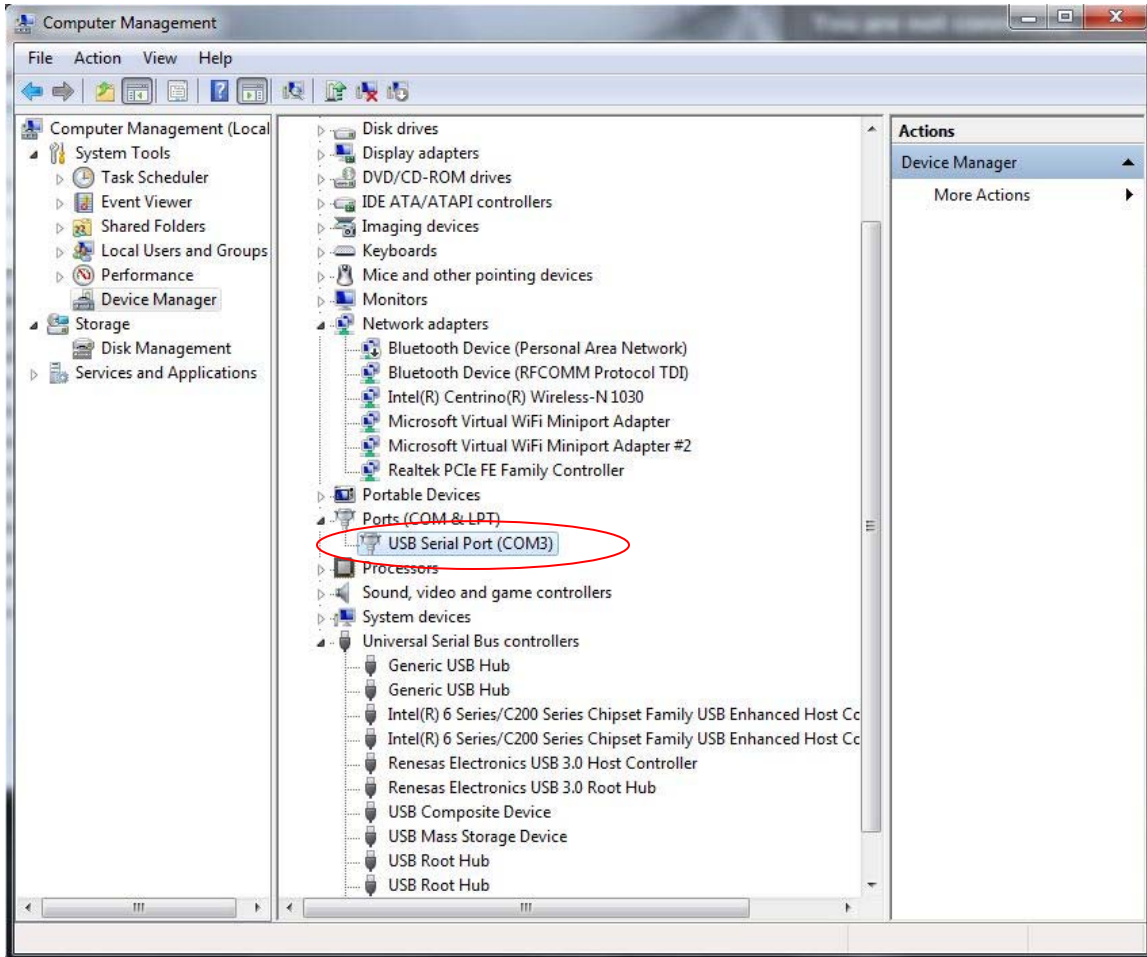

Note the port number that the ERM-202 is using (COM3, in this example).

The USB driver can drive more than one instrument, but the instruments will be connected under different port numbers.

## Appendix 4.0 Ethernet setup

There are two connection configurations for Ethernet control:

- a) Static IP: the administrator assigns the instrument a fixed IP address. In this mode the instrument can be directly connected to the control PC, as shown in Figure 9, or can be connected through a router. For a direct connection, as in Figure 9, a cross-linked network cable must be used. For a connection to a router, a standard straight-linked network cable would be used.
- b) Dynamic IP: the DHCP server assigns the instrument an available address when requested. Connect the instrument with a DHCP server (running on router or exchange server), as shown in Figure 10. For this configuration, a standard straight-linked network cable must be used.

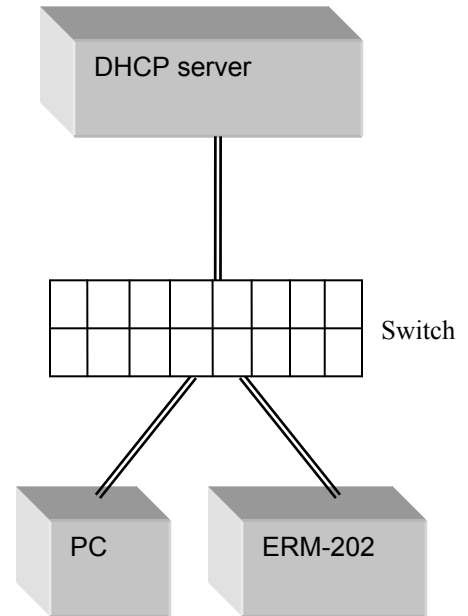
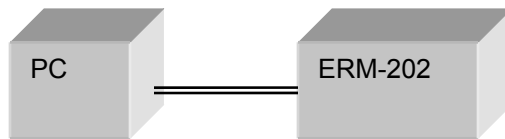

**Figure 9** Direct connection: ERM-202 to PC

**Figure 10** connect ERM-202 with DHCP server

Once the physical connections are established, there are two ways to set up the ERM-202's Ethernet configuration.

## Front Panel

Press the FUNC key and select "Get Dynamic IP" to set the ERM-202 for dynamic IP addressing and request a dynamic IP address from the server, or select "Static IP" to set the static IP parameters. See section 3.4 for details.

## LabView program

A LabView program provided with the instrument can also be used to query the IP address and perform static IP setup.

Open the LabVIEW program (SET\_ETHERNET.exe) to set the Ethernet configuration.

This program was designed for an RS-232 interface, so the instrument should be connected to the computer via RS-232 before running it. Please see the instructions in Appendix 2 for RS-232 setup. The program interface is shown below.

Select the correct serial (RS-232) port from the port configuration box at the top of the screen. The baud rate should be set to 9600. Once these two parameters are set, click the white arrow to run the program.

The program has 3 tabs. The first, "GET IP CONFIG" is used to query the current IP configuration of the ERM-202. When the "Get IP Config" button at the left of the screen is clicked, the program will read back the instrument's current IP address, net mask, gateway, nameserver, and port, as well as whether the instrument is currently set for static or dynamic IP addressing.

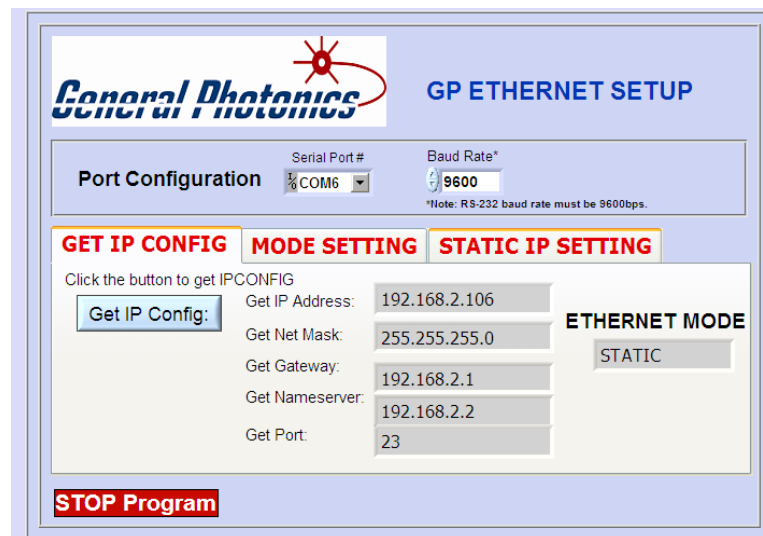

IP Config query screen- Static IP mode result



# ERM-202 User Guide

The screenshot shows the 'GP ETHERNET SETUP' interface. At the top left is the 'General Photonics' logo. Below it, the 'Port Configuration' section shows 'Serial Port #' set to 'COM6' and 'Baud Rate\*' set to '9600'. A note below the baud rate states: '\*Note: RS-232 baud rate must be 9600bps.' Below this are three tabs: 'GET IP CONFIG', 'MODE SETTING', and 'STATIC IP SETTING'. The 'GET IP CONFIG' tab is active, displaying a 'Click the button to get IPCONFIG' instruction and a 'Get IP Config:' button. To the right of the button are input fields for: 'Get IP Address: 192.168.2.110', 'Get Net Mask: 255.255.255.0', 'Get Gateway: 192.168.2.1', 'Get Nameserver: 192.168.2.2', and 'Get Port: 23'. To the right of these fields is the 'ETHERNET MODE' section, which has a 'DYNAMIC' button selected. At the bottom left of the screen is a 'STOP Program' button.

IP Config query screen- Dynamic IP mode result

Use this function to obtain the IP address, which is needed to control the ERM-202 via Ethernet.

The second tab, "MODE SETTING" allows the user to switch the ERM-202 between static and dynamic IP addressing modes.

The screenshot shows the 'GP ETHERNET SETUP' interface. At the top left is the 'General Photonics' logo. Below it, the 'Port Configuration' section shows 'Serial Port #' set to 'COM6' and 'Baud Rate\*' set to '9600'. A note below the baud rate states: '\*Note: RS-232 baud rate must be 9600bps.' Below this are three tabs: 'GET IP CONFIG', 'MODE SETTING', and 'STATIC IP SETTING'. The 'MODE SETTING' tab is active, displaying 'Select DYNAMIC Mode:' with an 'OK' button and a green indicator light, and 'Select STATIC Mode:' with an 'OK' button and a black indicator light. To the right of these options is the 'ETHERNET MODE' section, which has a 'DYNAMIC' button selected. At the bottom left of the screen is a 'STOP Program' button.

Ethernet mode selection screen- dynamic

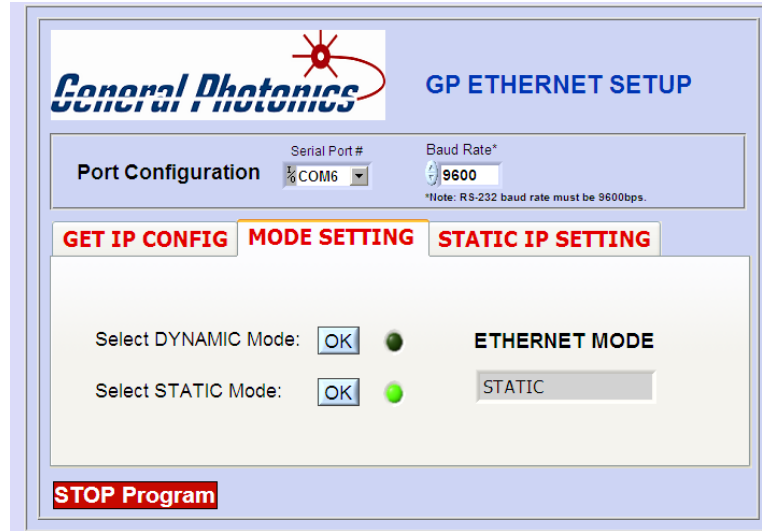

**Ethernet mode selection screen- static**

Clicking the "OK" button for dynamic mode puts the ERM-202 into dynamic IP mode. The instrument will obtain the dynamic IP information from the server. When it is finished, the indicator for dynamic mode will turn green, and the Ethernet Mode status box will say "DYNAMIC".

Clicking the "OK" button for static mode puts the ERM-202 into static IP mode. The instrument will recall the static IP settings from its memory. These can then be used for communication. When it is finished, the indicator for static mode will turn green, and the Ethernet Mode status box will say "STATIC".

The ERM-202 writes its most recently saved static IP settings and its active mode to memory. If it is powered off while in static mode, when it is powered back on, it will be in static mode, and the most recently saved set of IP configuration information can be used for communication.

If the ERM-202 is powered off while in dynamic IP mode, when it is powered back on, it will be in dynamic IP mode.

The third tab in the program, "STATIC IP SETTING", allows the user to set the static IP configuration information. Input the information into the corresponding boxes and click the "SET" button. As each value is written, its indicator turns green. When all of the information is successfully stored, the "Set OK" indicator will turn green.

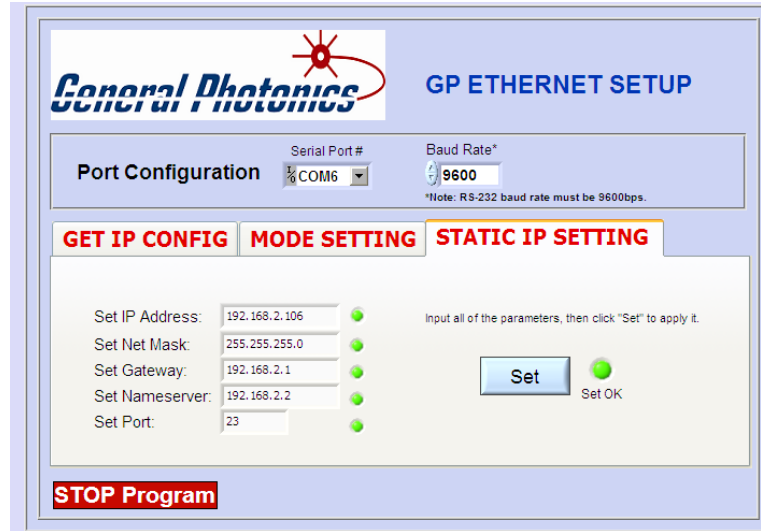

**Static IP setup screen.**

For static IP control, the net mask and gateway for the instrument should be the same as those for the control computer. The first 3 groups of numbers in the IP address should be the same as those for the control computer (192.168.2, for example). The last number can be any available number, but cannot be the same as the IP address of the control computer. The range of numbers is 1 to 254. If the computer's IP address is 17, for example, the user can set the IP address for the ERM-202 to any number in the range 1-254 except 17.

For static IP control, make sure that the control computer is also set to use a static (defined) IP address (check the TCP/IP properties to find the computer's Ethernet setup information).

For dynamic IP control, make sure that the control computer is set to obtain its IP address automatically. This information is also under TCP/IP properties.

- To connect the instrument directly to a PC, use a PC to PC cable. To connect the instrument to a LAN, use a standard network cable.
- For Ethernet control, the serial port is only used during Ethernet setup (if using the LabView Ethernet setup program).

### Appendix 5.0 GPIB setup and control

To change the GPIB address, press the FUNC button and select "1. GPIB Address".



GPIB Address: 05

Use the UP/DOWN arrow keys (▲, ▼) to change the address.

Range: 1-30

Press ENTER to save the setting.

#### GPIB control

Connect the instrument to the computer with a GPIB cable. After determining/setting the ERM-202's GPIB address, select the corresponding port number in the corresponding box of the LabView control program (see Appendix 6) and run the control program.

In addition to using the provided control programs, individual commands can be sent through the GPIB port. Enter the GPIB address in the communication program being used. The instrument will then be ready to receive commands. The command list is given in Table 1 and Table 2 in Appendix 1.

To ensure proper communication, use a GPIB cable that is fully compatible with the IEEE 488.1 standard. All GPIB/IEEE 488 interface connections must be made before turning on the instruments.

## Appendix 6.0 LabView control program

LabView control programs are provided for remote control of the ERM-202. If LabVIEW is not installed on the control computer, install the LabVIEW Run-Time engine (LV2012SP1\_Run-time engine), and the VISA driver (NIVISA1401runtime). These run-time engines are compatible with Windows 8/7/XP.

For USB control, the USB drivers need to be installed. See Appendices 2-5 for details on setup for specific communication interfaces.

Always close the control program before turning off the instrument.

### RS-232/USB/GPIB

The control programs "ERM-202S/D-InstrumentMain-VISA.exe" (executable) are compatible with RS-232, USB and GPIB interfaces. These programs will auto-sense which interface is being used and display the appropriate port configuration option. The control program interface is otherwise identical for RS-232, USB and GPIB control.

Open the "ERM-202S/D-InstrumentMain-VISA" program. It will show the long term measurement screen. Run the program by clicking the white arrow at the top of the page or the Start Program button at the bottom of the page. The program will jump to the "Setup" tab and start searching for available ports. After the search is complete, the indicator dot at the right of the screen will turn green, and the pull-down menu on the left will display all available ports. Select a communication port from the list.

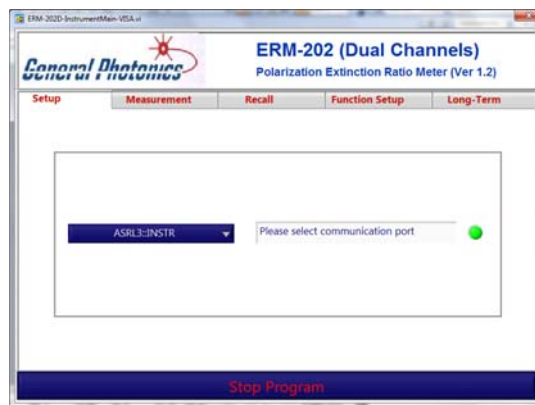

(a) ASRLX::INSTR is the same as COMX for RS-232.

(b) GPIB::XX::INSTR refers to the GPIB port with an address of XX.

## Ethernet

The control programs “ERM-202S/D-InstrumentMain-Ethernet.exe” (executable) are for use with the Ethernet interface.

Open the control program and click either the white arrow at the top of the page or the Start Program button to run it. Enter the instrument’s IP address and port number and click Connect to establish the connection. If the connection is successful, the connection status indicator dot will turn green and the instrument product number will be displayed in the bottom text box.

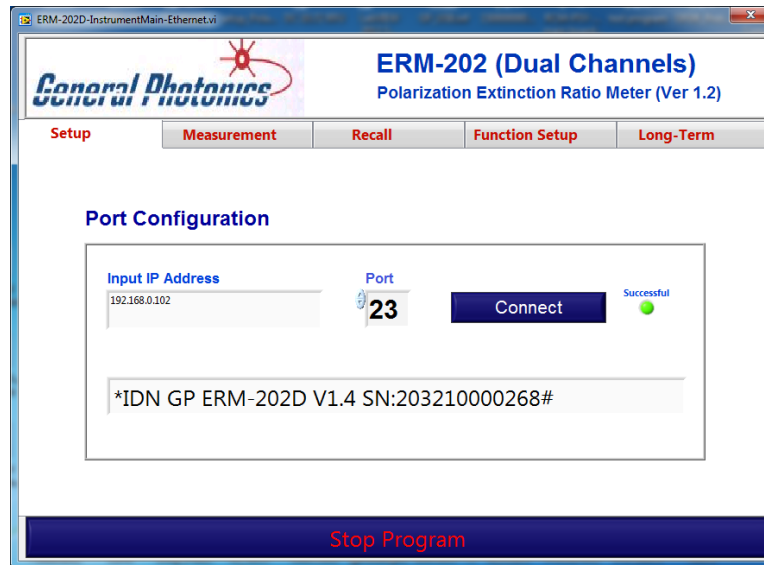

Connection successful

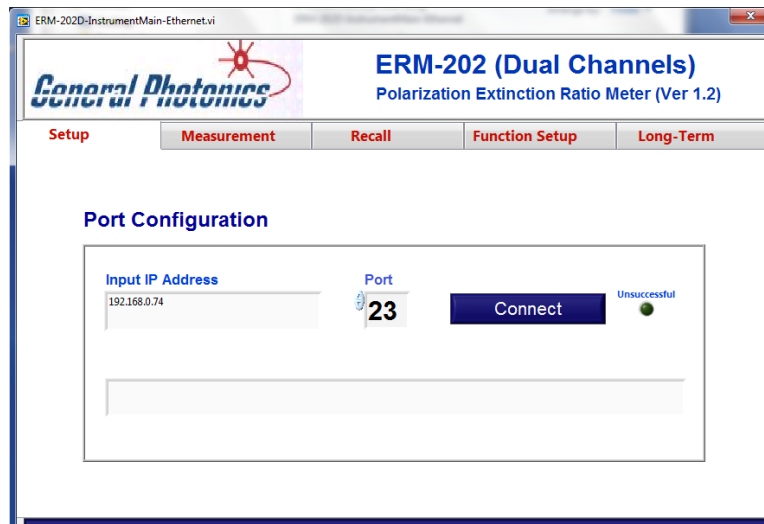

Connection failed

# ERM-202 User Guide

## Program Interface

The "Measurement" tab brings up the main measurement screen.

Select the desired measurement mode from the pull-down menu at the bottom of the screen and click the Set button.

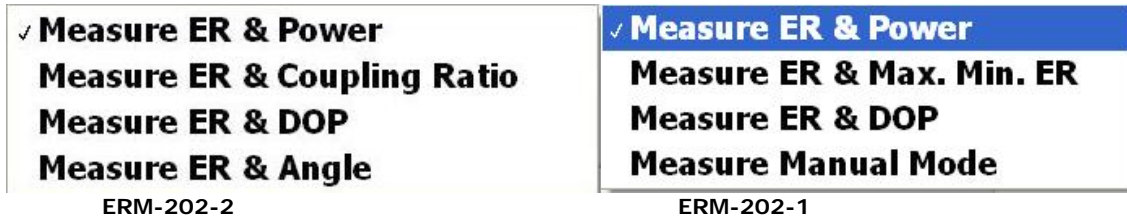

Measured values displayed in the control program data window may not exactly match values displayed on the instrument's front panel. This is because the refresh rates for the remote and local data displays are different and/or not synchronized, so they may be displaying the results of different measurements.

### ER and Power

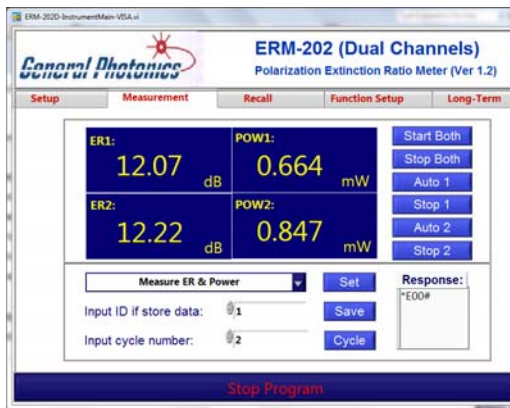

ERM-202-2

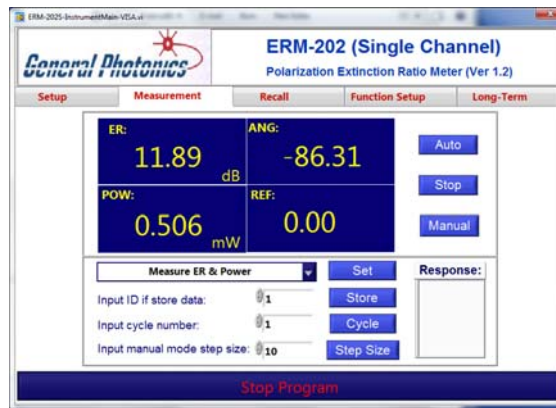

ERM-202-1

The "ER & Power" measurement screen displays the following data:

ER1: Measured PER of channel 1, in dB.	ER: Measured PER, in dB.
ER2: Measured PER of channel 2, in dB.	POW: Input Power, in mW or $\mu$ W.
POW1: Input power, channel 1, in mW or $\mu$ W.	ANG: Polarization angle, in degrees.
POW2: Input power, channel 2, in mW or $\mu$ W.	REF: Reference angle, in degrees.

The control buttons on the right side of the screen and the Save and Cycle buttons at the bottom of the screen are common to all of the measurement modes. Their functions are as follows:

## ERM-202 User Guide

ERM-202-2		ERM-202-1
Start Both:	Begin measurement on both channels 1 and 2.	Auto: Begin automatic measurement.
Stop Both:	Stop measurement on both channels 1 and 2.	Stop: Stop measurement.
Auto 1:	Begin measurement on channel 1.	Manual: Enable manual measurement mode; polarizer angle rotates one step per click.
Stop 1:	Stop measurement on channel 1.	Step Size: Set the rotation angle in Manual operation mode, in multiples of 0.06°. The step size range is 0.06° to 90° (multiplier range is 1 to 1500). In the example above, the step size is 0.6° (= 10 * 0.06°).
Auto 2:	Begin measurement on channel 2.	
Stop 2:	Stop measurement on channel 2.	

Buttons common to both versions:

**Save/Store:** Store current measured values to the specified storage location. To store the data currently displayed, type or select a storage location (ID#0-99) in the storage location box and click the Save or Store button. Data can be stored from any measurement mode.

**Cycle:** Set the number of polarizer rotation cycles averaged per measurement. To select the number of polarizer rotation cycles used for averaging, type or select the desired number in the cycle selection box and click the Cycle button.

The Response window displays the instrument response to the latest command sent. In most cases, the response to a successfully sent command should be "\*E00#".



# ERM-202 User Guide

## ER and Coupling Ratio (ERM-202-2 only)

ERM-202D-InstrumentMain-VISA.vi

**General Photonics**

**ERM-202 (Dual Channels)**  
Polarization Extinction Ratio Meter (Ver 1.2)

Setup Measurement Recall Function Setup Long-Term

<b>ER1:</b> 12.94 dB	<b>P1/(P1+P2):</b> 43.950 %	Start Both
<b>ER2:</b> 13.08 dB	<b>P1/P2:</b> 0.780	Stop Both
		Auto 1
		Stop 1
		Auto 2
		Stop 2

Measure ER & Coupling Ratio Set

Input ID if store data: 1 Save

Input cycle number: 2 Cycle

Response:  
\*E00#

Stop Program

The "ER & Coupling Ratio" measurement screen displays the following data:

ER1: Measured PER of channel 1, in dB.

ER2: Measured PER of channel 2, in dB.

$P1/(P1+P2)$ : Coupling ratio =  $P1/(P1+P2)*100\%$  = Channel 1 power as a percentage of the total power (ch1 power + ch2 power). This function can be used for PM coupler characterization.

$P1/P2$ : Power split ratio  $P1/P2$  = the ratio of power in channel 1 to power in channel 2.

## ERM-202 User Guide

### ER and Max/Min ER measurement (ERM-202-1 only)

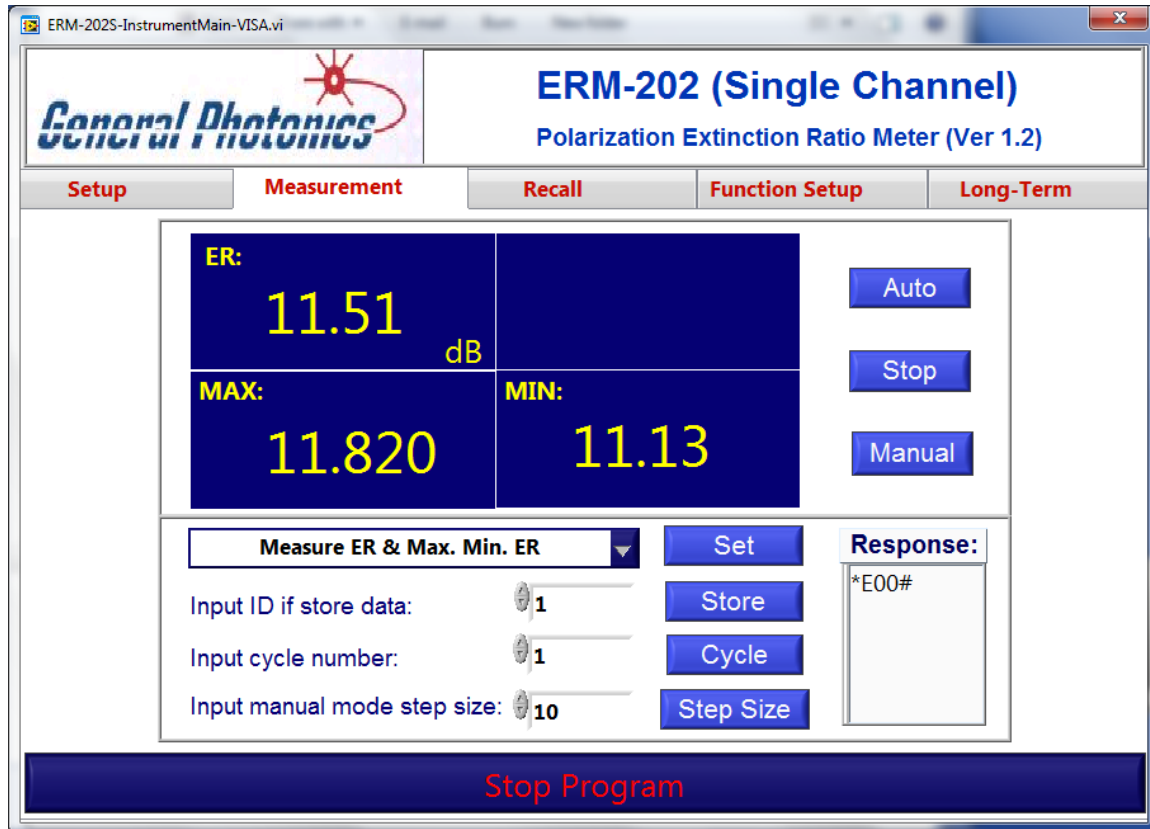

The "ER & Max. Min. ER" measurement screen displays the following data:

- ER: Measured PER, in dB (results of most recent measurement).
- MAX: Maximum ER value measured during the current measurement period, in dB.
- MIN: Minimum ER value measured during the current measurement period, in dB.

To reset the Max/Min values and begin a new measurement period, click the "Set" button with "Measure ER & Max. Min. ER" selected from the pull-down menu.

# ERM-202 User Guide

## ER and DOP

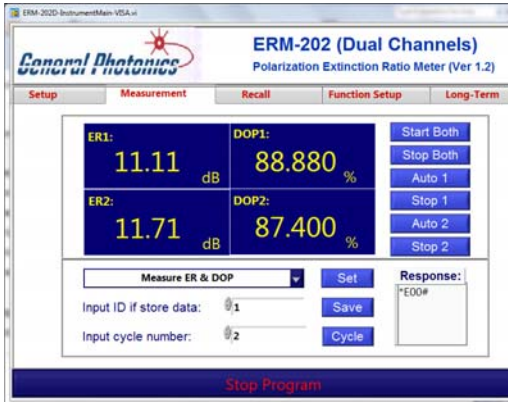

ERM-202-2

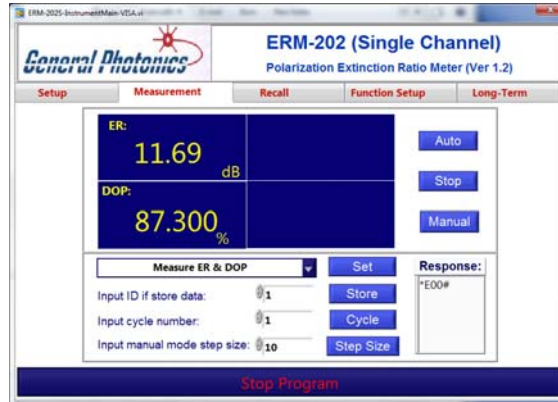

ERM-202-1

The "ER & DOP" measurement screen displays the following data:

ER1: Measured PER of channel 1	ER: Measured PER
ER2: Measured PER of channel 2	DOP: Estimated DOP
DOP1: Estimated DOP of channel 1	
DOP2: Estimated DOP of channel 2	

## ER and Angle (ERM-202-2 only)

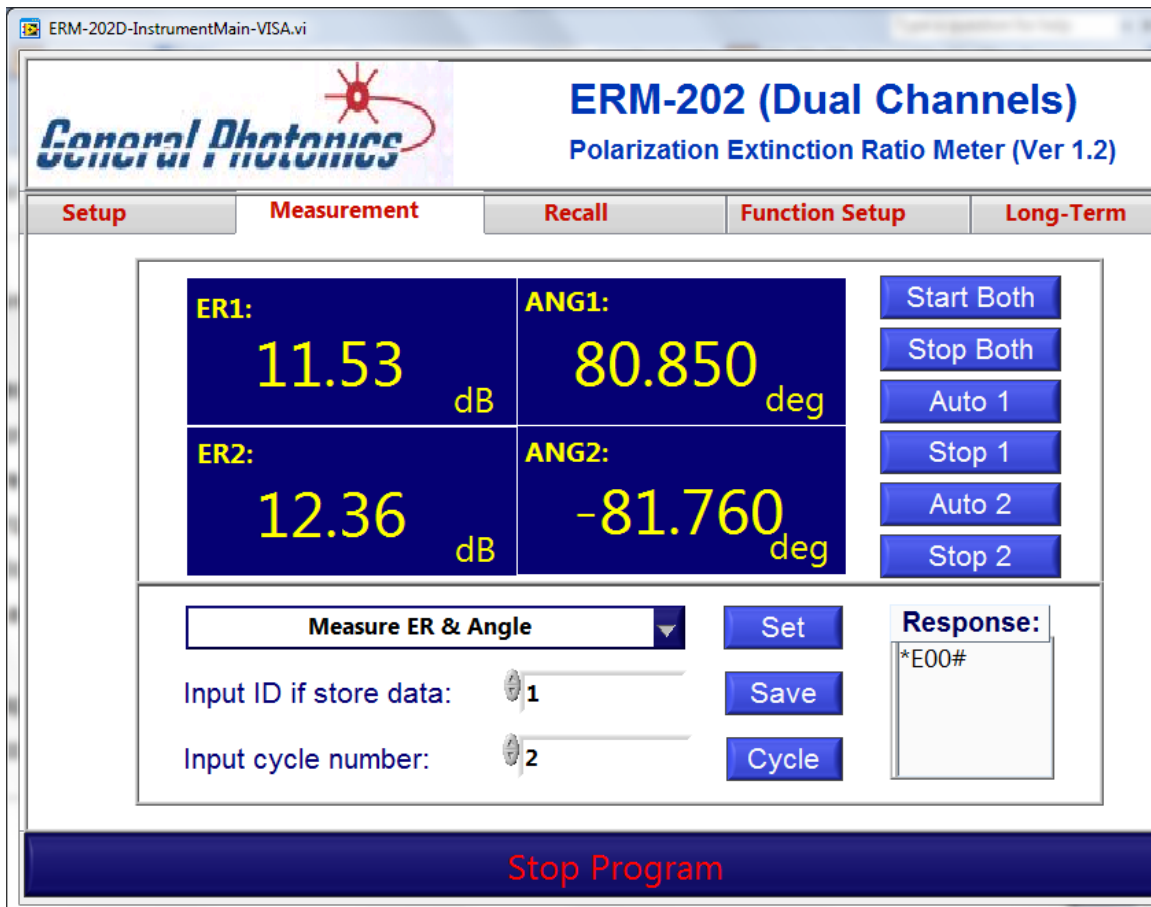

## ERM-202 User Guide

The "ER & ANGLE" screen displays the following data:

ER1: Measured PER of channel 1, in dB.

ER2: Measured PER of channel 2, in dB.

ANG1: Polarization angle of channel 1, relative to the channel 1 reference angle, in degrees.

ANG2: Polarization angle of channel 2, relative to the channel 2 reference angle, in degrees.

### Manual (ERM-202-1 only)

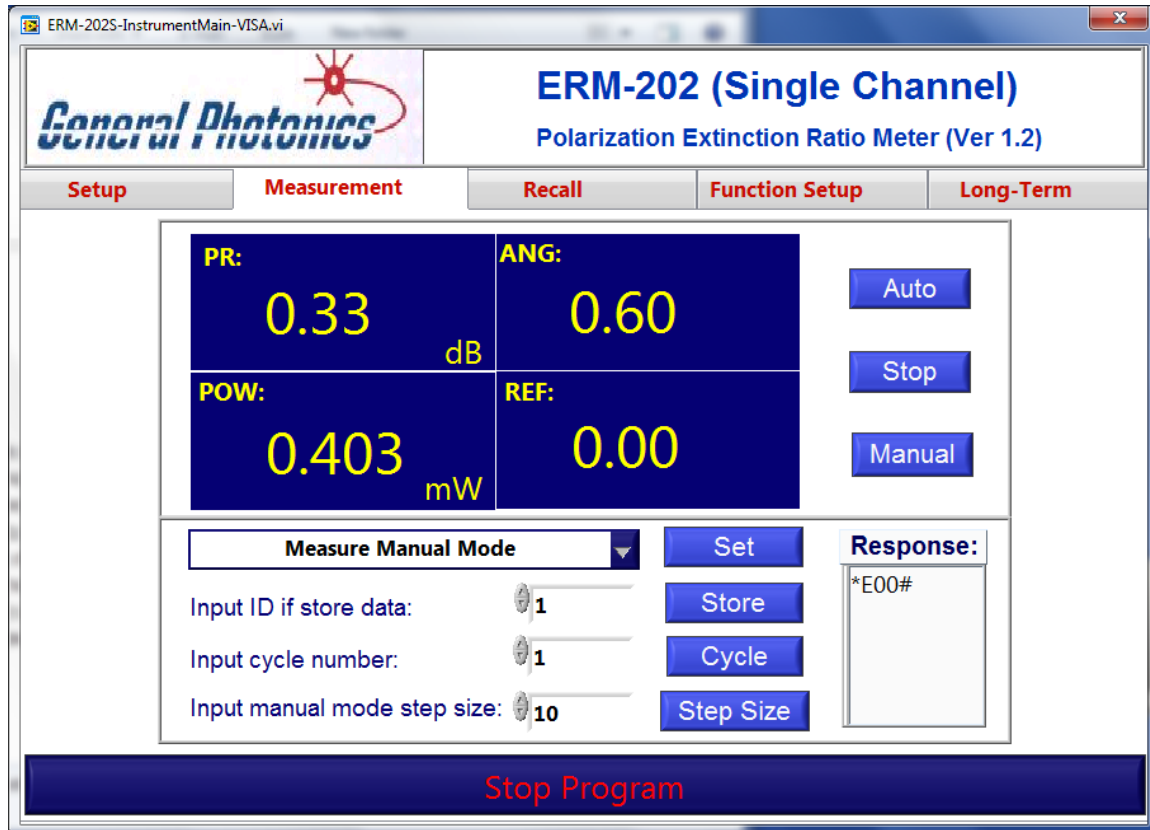

The "Manual Mode" screen displays the following data:

PR: The power ratio, in dB, between the measured power at the current polarizer angle and the minimum power measured during the manual mode initialization step

POW: Measured power in mW or  $\mu$ W.

ANG: Current polarizer angle relative to reference angle, in degrees.

REF: Reference angle, in degrees.

To reinitialize manual measurement (take a new minimum power measurement to calculate the power ratio and reset the polarizer angle to vertical), exit manual mode by selecting some other measurement mode from the pull-down menu and clicking "Set", then re-select manual mode and click "Set".

# ERM-202 User Guide

The remaining tabs access functions to recall stored data, set control parameters, and perform a long-term measurement.

## Recall

ERM-202D-InstrumentMain-VISA.vi

**General Photonics**

**ERM-202 (Dual Channels)**  
Polarization Extinction Ratio Meter (Ver 1.2)

Setup Measurement **Recall** Function Setup Long-Term

Start ID  End ID  **Recall** ●

ID:1	ER1:12.86	Pow1: 0.66420mw	ER2:12.14	Pow2: 0.85133mw
ID:2	ER1:10.96	Pow1: 0.65524mw	ER2:17.24	Pow2: 0.83176mw
ID:3	ER1:12.55	Pow1: 0.63738mw	ER2:12.21	Pow2: 0.81733mw
ID:4	ER1:10.52	P1/(P1+P2): 43.89	ER2:12.63	P1/P2: 0.78
ID:5	ER1:12.12	P1/(P1+P2): 44.05	ER2:12.62	P1/P2: 0.79
ID:6	ER1:12.21	P1/(P1+P2): 43.97	ER2:12.39	P1/P2: 0.78
ID:7	ER1:11.06	DOP1: 85.46	ER2:11.63	DOP2: 87.14
ID:8	ER1:11.17	DOP1: 85.81	ER2:16.25	DOP2: 95.37
ID:9	ER1:11.06	DOP1: 85.47	ER2:17.46	DOP2: 96.47
ID:10	ER1:11.02	ANG1: 81.35	ER2:17.36	ANG2: -76.40
ID:11	ER1:14.30	ANG1: -78.79	ER2:14.34	ANG2: 82.30
ID:12	ER1:12.35	ANG1: -81.42	ER2:12.45	ANG2: 85.97

**Stop Program**

ERM-202-2

## ERM-202 User Guide

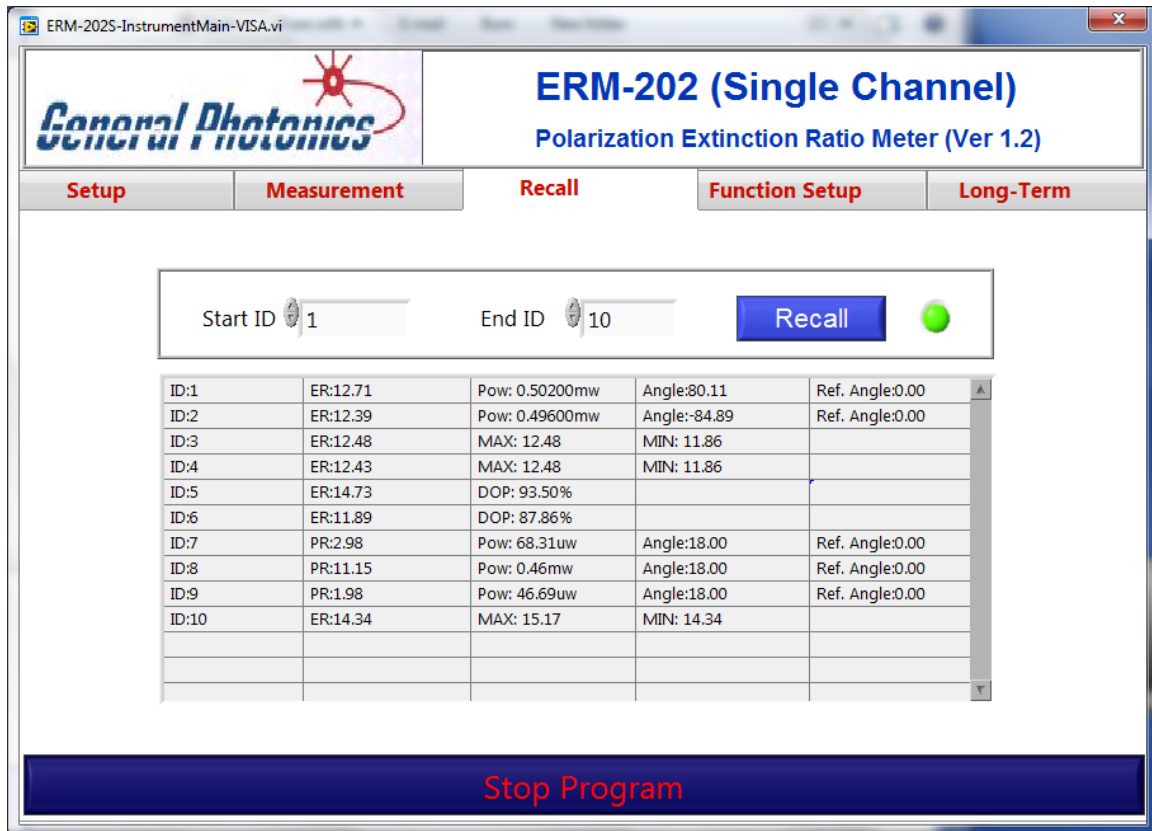

### ERM-202-1

The recall screen is used to retrieve stored data from memory. Select the range of data to be recalled: Type or use the up and down arrows to input the desired Start and End storage location IDs in the corresponding boxes, and then click "Recall" to display the data on screen. The indicator dot next to the Recall button will turn green after the data is successfully recalled.

### Function Setup

This screen is used to set and query various control parameters for general ERM-202 operation. Click the buttons in the "Query" section to query the current settings of the corresponding parameters. After a query button is clicked, the corresponding indicator window will show the current stored value for that parameter.

To change a setting, type the new value in the corresponding box on the "Set" side of the screen and click the "Set" button next to the box. Ranges for each parameter are listed to the right of its "Set" button.

After setting new parameters, use the Query buttons to check that the new settings were successfully stored.

After each button is clicked, the ERM-202's response is displayed in the "Response" box at the bottom of the page. The response to a successful "Set" command is generally \*E00#, while the response to a successful query command is the requested data.

# ERM-202 User Guide

ERM-202D-InstrumentMain-VISA.vi



## ERM-202 (Dual Channels)

Polarization Extinction Ratio Meter (Ver 1.2)

Setup Measurement Recall Function Setup Long-Term

Query:	GPIB	*ADR 10#	←	10	Set	(1~30)
	wavelength1	*WAV1 1550#	←	1550	Set	(1550/1310)
	wavelength2	*WAV2 1550#	←	1550	Set	(1550/1310)
	connector1	*TYP1 PC#	←	PC	Set	(PC/APC)
	connector2	*TYP2 PC#	←	PC	Set	(PC/APC)
	speed	*SPD 0.4s#	←	0.4	Set	(0.1/0.2/0.4/1.0)
	standtime	*TIM 00#	←	30	Set	(0/10/15/20/25/30)
	reference 1	*REF1 0.00#	←	0	Set	(-90~90)
	reference 2	*REF2 0.00#	←	0	Set	(-90~90)

Responses

Stop Program

ERM-202S-InstrumentMain-VISA.vi



## ERM-202 (Single Channel)

Polarization Extinction Ratio Meter (Ver 1.2)

Setup Measurement Recall Function Setup Long-Term

Query:	GPIB	*ADR 10#	←	10	Set	(1~30)
	wavelength	*WAV 1550#	←	1550	Set	(1550/1310)
	connector	*TYP PC#	←	PC	Set	(PC/APC)
	speed	*SPD 0.4s#	←	0.4	Set	(0.1/0.2/0.4/1.0/10)
	standtime	*TIM 00#	←	30	Set	(0/10/15/20/25/30)
	reference	*REF 0.00#	←	0	Set	(-90~90)

Responses: \*E00#

Stop Program

# ERM-202 User Guide

ERM-202-2	ERM-202-1
GPIB: GPIB address of ERM-202	GPIB: GPIB address of ERM-202
Wavelengthx: Calibrated wavelength setting for channel x	Wavelength Calibrated wavelength setting
Connectorx: Connector type setting (PC or APC) for channel x	Connector Connector type setting (PC or APC)
Speed Polarizer rotation speed (time, in seconds, required for 1 polarizer rotation)	Speed Polarizer rotation speed (time, in seconds, required for 1 polarizer rotation)
Standtime Noninteraction period (in minutes) before the ERM-202 enters standby. Note: 0 = standby disabled.	Standtime Noninteraction period (in minutes) before the ERM-202 enters standby. Note: 0 = standby disabled.
Referencex Reference angle, in degrees, relative to which the polarization angle for channel x is to be measured. 0° corresponds to the vertical direction.	Reference Reference angle, in degrees, relative to which the polarization angle is to be measured. 0° corresponds to the vertical direction.

## Long Term Monitoring

The long-term monitoring screen allows the user to track the evolution of measured data over time. Select the measurement mode from the pull-down menu at the bottom of the screen. Available options are "ER & Power", "ER & Coupling Ratio", "ER & DOP", and "ER & Angle" modes for the ERM-202-2, and "ER & Power", "ER & Max.Min.ER", and "ER & DOP" modes for the ERM-202-1. Set the monitoring period ("Monitor Time"), in minutes, and the time interval between measurements ("Interval"), in seconds, by typing the numbers in the corresponding boxes or by using the up and down arrows. Click the "Start long-term monitoring" button to begin measurement. The program will prompt the user for a file name and location to store the measured data. After the file information is entered, the program will begin recording data and plotting it on screen. During monitoring, the indicator dot at the bottom right of the screen will remain green.

To stop data collection before the full monitoring period has elapsed, click the "Stop long-term monitoring" button.

