

MPC-203

High Speed Multifunction Polarization Control System



User Guide

Version: 1.1
Date: June 20, 2018

General Photonics Corporation is located in Chino California.

For more information visit the company's website at:

www.generalphotonics.com

or call 909-590-5473

SAFETY CONSIDERATIONS

The following safety precautions must be observed during operation of this product. Failure to comply with these precautions or with specific warnings elsewhere in this manual violates safety standards of design, manufacture, and intended use of the product. General Photonics assumes no liability for customers' failure to comply with these requirements.

Before operation, the user should inspect the product and review the manual carefully.

Properly ground the chassis and work space using the chassis ground terminal.

Use only in a safe work environment in terms of temperature, humidity, electrical power and risk of fire or shock. The product is designed for indoor use. Avoid exposure to liquids or water condensation. Provide adequate ventilation for cooling.

Operate the product on a stable surface. Avoid excess vibration.

Standard laser safety procedures should be followed during operation.

Never look into the light source fiber connector when the light source is turned on. THE OUTPUT LIGHT FROM A HIGH POWER LASER IS HARMFUL TO HUMAN EYES. Follow industry standard procedures when operating a high power laser source.

Section 1.0	Overview	7
1.1	Principle of Operation.....	7
Section 2.0	Features	11
2.1	Front Panel and Optical Inputs	11
	<u>Fiber Connectors</u>	<u>12</u>
	<u>Ferrule Cleaning Procedure</u>	<u>12</u>
2.2	Rear Panel: Electrical and Remote Control Interfaces	13
Section 3.0	Operation Instructions	15
3.1	Unpacking	15
3.2	Front Panel Operation	15
3.3	Operation Modes	17
	<u>Polarization Scrambling</u>	<u>17</u>
	<u>11896 Scrambling</u>	<u>26</u>
	<u>Manual Polarization Control</u>	<u>28</u>
	<u>Polarization Modulation</u>	<u>30</u>
	<u>System Setup</u>	<u>36</u>
	<u>System Reset</u>	<u>41</u>
3.4	Troubleshooting	42
	<u>Front Panel</u>	<u>42</u>
	<u>Remote Control</u>	<u>42</u>
Section 4.0	Specifications	43
	<u>Optical</u>	<u>43</u>
	<u>Electrical/Communication</u>	<u>43</u>
	<u>Physical and Environmental</u>	<u>43</u>
	<u>System</u>	<u>43</u>
	<u>Polarization Scrambler</u>	<u>43</u>
	<u>Polarization Control</u>	<u>44</u>
	<u>Polarization Modulation (function generator)</u>	<u>44</u>

WARRANTY..... 45

Appendices 46

Appendix 1.0 Remote Control Commands 46
 Command Lists.....46

Appendix 2.0 RS-232 connection and setup 57

Appendix 3.0 USB connection and setup 59
 USB Driver Installation59

Appendix 4.0 Ethernet setup..... 65

Appendix 5.0 GPIB setup and control..... 67
 Setting the GPIB Address.....67
 GPIB control.....67

Section 1.0 Overview

The MPC-203 is a version of General Photonics' Multifunction Polarization Controller specifically designed for system testing that requires fast polarization change rates. It combines a high speed version of General Photonics' PolaRite™ III polarization controller with proprietary control algorithms to achieve a wide range of polarization control functionalities: manual polarization control, polarization function generation/modulation, and polarization scrambling, with maximum SOP variation rates in tornado scrambling mode of up to 11 Mrad/s. The instrument contains a microprocessor based control circuit packaged in a 2U-height, $\frac{3}{4}$ -rack size package, as shown in Figure 1. The all-fiber construction polarization controller provides very wide operation bandwidth with low insertion loss, polarization dependent loss, and activation loss.



Figure 1 MPC-203 Multifunction Polarization Controller

1.1 Principle of Operation

A polarization controller can be constructed either from a series of rotatable fixed-retardation plates or a series of variable retardation plates of fixed orientation. An example of this second construction, with four variable retardation wave plates, is shown in Figure 2a. A fiber-based version of this design which consists of four piezoelectric actuator-driven fiber squeezers oriented at 0° - 45° - 0° - 45° is shown in Figure 2b. Each fiber squeezer is driven by an applied voltage signal. Squeezing the optical fiber produces a linear birefringence in the fiber, which alters the state of polarization of a light signal passing through it. The MPC-203 is built around a modified version of this design that is capable of very high speed.

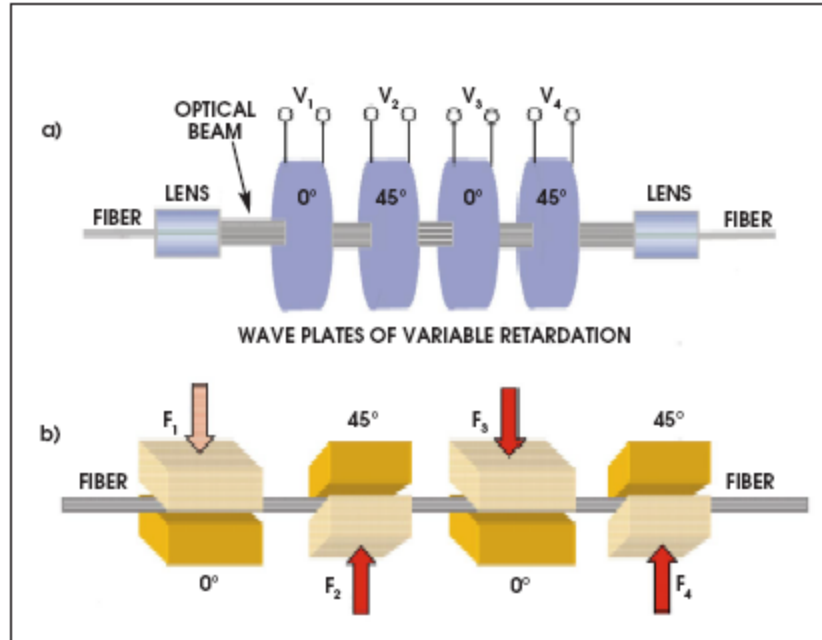

Figure 2 a) Free space construction of variable retardation plate polarization controller. b) Fiber squeezer construction of variable retardation plate polarization controller.

An arbitrary polarization state of monochromatic light can be represented by a single point on the Poincaré Sphere, as shown in Figure 3. Increasing the voltage on one fiber squeezer (X1 or X3) increases the pressure from that squeezer, causing the polarization state to rotate clockwise about the OQ axis. Decreasing the voltage causes the point to rotate counterclockwise. Similarly, increasing or decreasing the voltage on a second fiber squeezer (X2 or X4) oriented 45° from the first one causes the polarization state to rotate clockwise or counterclockwise about an axis (OH axis) orthogonal to the first one.

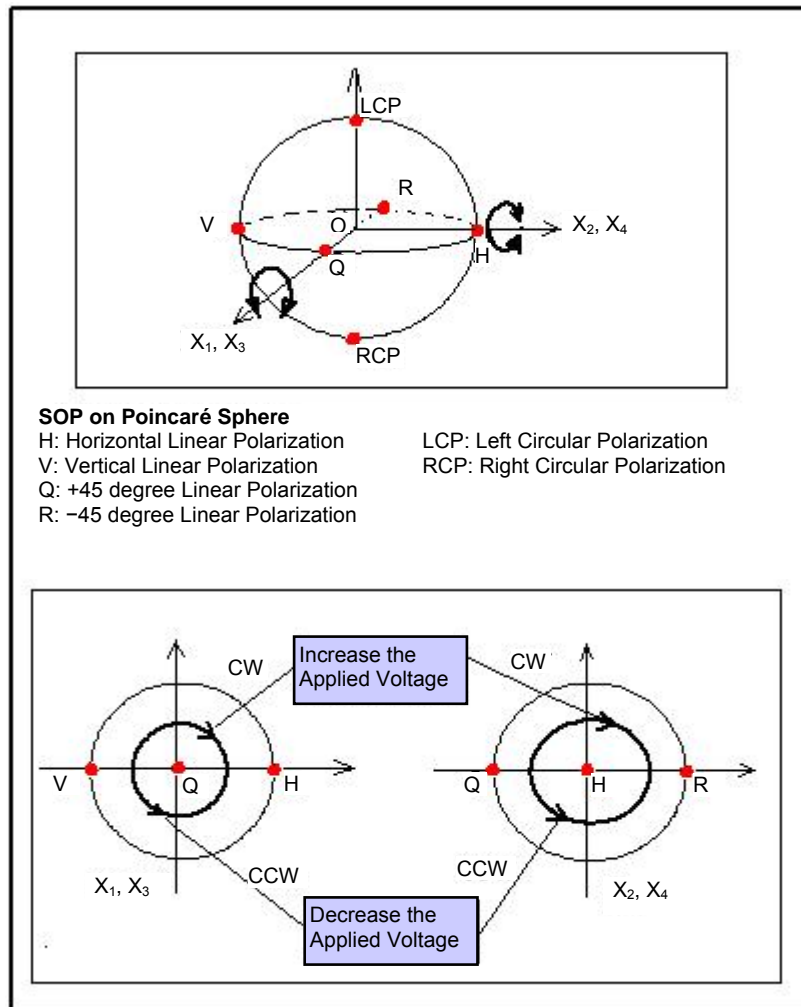

Figure 3 Poincaré Sphere SOP representation and illustration of effects of fiber squeezers

Using different modes of control of the drive voltages, the polarization controller can perform various functions. In manual control mode, the user has direct control over the output polarization state. By adjusting the DC drive voltage to each of the 4 fiber squeezers via the front panel, the output polarization can be changed from any initial state to the desired final state.

If the output polarization is required to change with time in a controlled fashion, the built-in waveform generator can generate a sine, triangle, or square wave of user-controlled amplitude, offset, and frequency on each of the 4 channels. This function can be used to accomplish anything from a simple periodic switching between two polarization states to a periodic sweeping out of a complicated pattern on the Poincaré sphere.

When acting as a polarization scrambler, the MPC-203 varies the output polarization state for even coverage of the Poincaré sphere using either a series of discontinuous random points (discrete scrambling) or a continuous trace (triangle, Rayleigh, and Tornado scrambling). The continuous scrambling methods create different SOP trace patterns and SOP variation rate

MPC-203 User Guide

distributions. The MPC-203 also has a triggered random state generation function, in which it generates a random polarization state triggered by the rising or falling edge (user-selectable) of an input TTL trigger signal.

Section 2.0

Features

2.1 Front Panel and Optical Inputs

The front panel of the MPC-203 is shown in Figure 4.

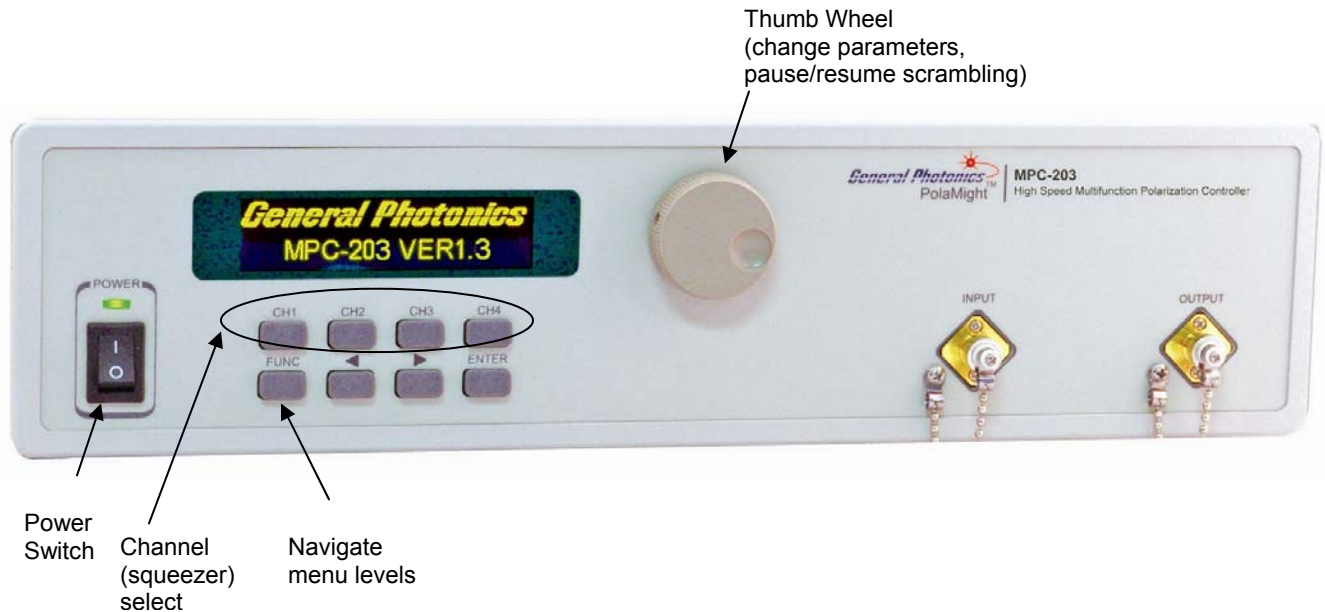

Figure 4 MPC-203 front panel

Front panel features:

- OLED display: Displays data and operation mode information
- Power: Power on/off switch
- Input: Adapter for optical fiber input
- Output: Adapter for optical fiber output
- CH1-CH4: Channel select (in modes with individual channel control)
- FUNC: Navigate the menu levels. Pressing FUNC moves one level up in the menu hierarchy.
- ENTER: Select menu option or move to setup for next parameter.
- ◀ ▶: Navigate selections or move cursor position
- Thumb wheel
Rotate: Move between menu selections
Increment/decrement active digit
Press Pause/resume scrambling or modulation

Fiber Connectors

The MPC-203 has two fiber connectors on the front panel to accommodate the input and output optical beams. The front panel adapters are universal connector interfaces (UCI), which feature a male-type adapter top piece that can be removed for direct access to the ferrule end for routine cleaning and maintenance without removing the entire adapter from the panel. This feature helps avoid high insertion loss, high return loss and measurement instability caused by dirty or contaminated connectors. In addition, the MPC-203's universal interchangeable adapter allows the user to switch to ST, SC, or FC connectors without opening the instrument panel. Although the MPC-203 is shipped with a customer specified fiber adapter, other interchangeable inserts are available. For additional information on different input fiber adapter inserts, please contact General Photonics.

External fiber connectors should be cleaned using industry standard cleaning methods before connection to the MPC-203. If this procedure is followed before each connection, the instrument's internal connector ferrules should not need regular cleaning. However, high insertion loss or measurement instability that does not improve after cleaning the external connectors may indicate that the instrument's internal connector ferrules require cleaning.

Ferrule Cleaning Procedure

Each connector ferrule is contained in a universal connector interface consisting of a front piece that connects to the external fiber connector, and a base piece that is mounted on the front panel of the instrument, as shown in Figure 5. To clean a connector ferrule, first, make sure no external connector is connected to the universal connector interface. Then, using a Phillips screwdriver, remove the two small screws connecting the front and back parts of the adapter, and carefully pull the front flange straight out. (Note: never remove the adapter base from the front panel). The ferrule end should now be exposed. Clean the ferrule using standard cleaning procedures (compressed air or a fresh lint-free tissue and alcohol or other connector-cleaning solvent), taking care to avoid scratching the ferrule surface. Finally, replace the front flange (position it so that the key notch faces up, and the small alignment pin lines up with the hole in the base piece, before pushing it in) and the screws. For frequent measurements, we recommend that the user prepare a patch cord fiber to avoid wear on the internal connector.

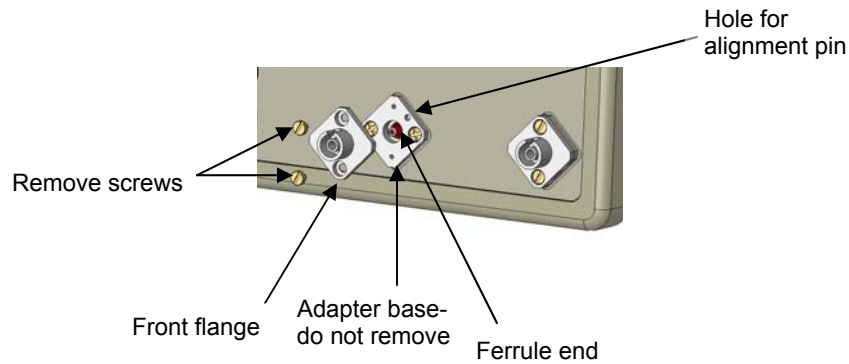

Figure 5 Diagram of universal connector interface

2.2 Rear Panel: Electrical and Remote Control Interfaces

The AC power plug, fuse, trigger and communication interface connectors are mounted on the rear panel, as shown in Figure 6.

The MPC-203 includes RS-232, USB, Ethernet, and GPIB interfaces for external computer operation of the system. Control commands, USB driver installation instructions, and other setup information for remote interfaces are located in the appendices.

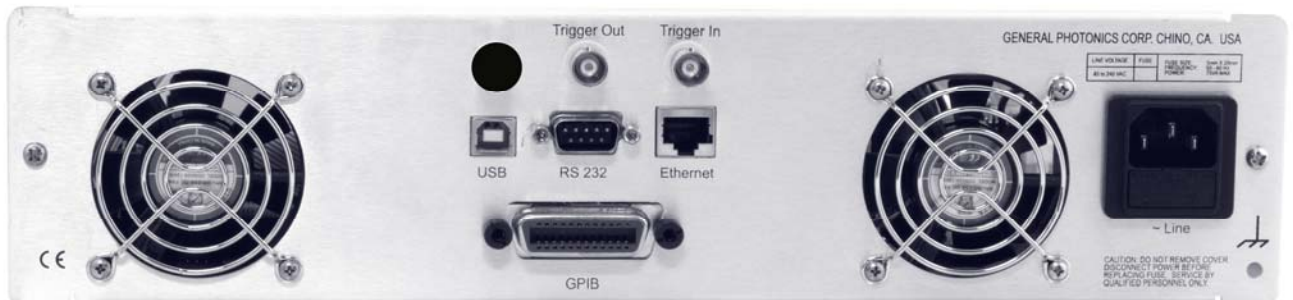

Figure 6 rear panel

Rear Panel Features:

Trigger Out: BNC for output trigger	Line: External AC input connector
Trigger In: BNC for input trigger	Cooling fan
USB 2.0 interface port	⏏: Chassis ground
RS-232 serial interface port	
Ethernet interface port	
GPIB interface port	

Fuse location:

Figure 7 shows the location of the fuse compartment under the power cord plug. There are two fuses in the compartment- the one in use and a spare. The fuse further inside the compartment is active. The one closer to the compartment opening is the spare.

Replace the fuse with one with the exact rating of the original.



Figure 7 Fuse compartment

Section 3.0 Operation Instructions

3.1 Unpacking

Inspect MPC-203 for any physical damage due to shipping and transportation. Contact carrier if any damage is found. Check the packing list to see if any parts or accessories are missing.

Packing List

Item #	Description
1	MPC-203
2	Power cord
3	RS-232 cable (straight-wired)
4	USB cable
6	User guide
7	Software cd

3.2 Front Panel Operation

1. Connect power cord and plug it into wall receptacle. Make sure the ground pin of the power cord is connected to earth ground.
2. Connect input and output fibers. Make sure laser source is turned off while cleaning connectors and making connections.
3. Turn on the instrument. It will run through an initialization sequence, during which the OLED screen will display the instrument identification. Once the initialization is complete, it will display the mode selection options (items 1-6 in the first level of the menu tree shown in Figure 8).

MPC-203 User Guide

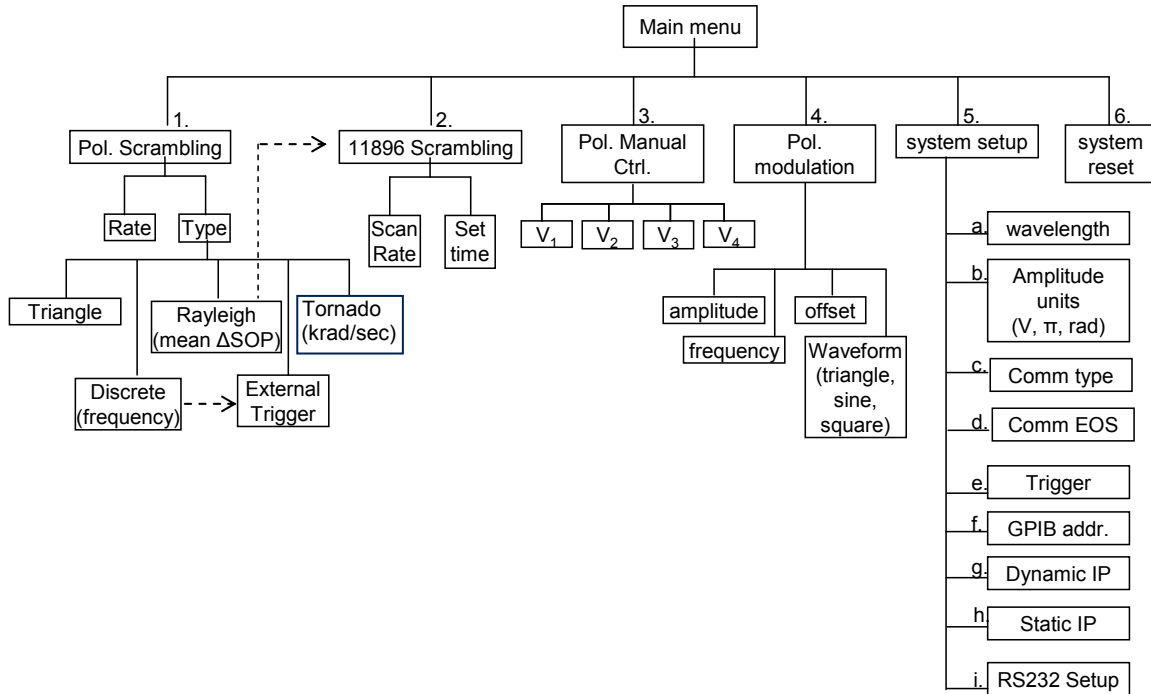
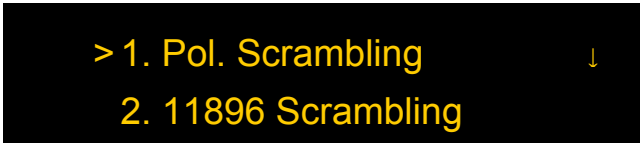

Figure 8 System Menu Tree



The screen displays two options at a time. Rotate the wheel or use the ◀▶ keys to move between options, then use the ENTER key to select the highlighted option.

3.3 Operation Modes

The MPC-203 has four main-menu operation mode groups: polarization scrambling, Agilent 11896A scrambling emulation, manual polarization control, and polarization modulation (waveform generation).

Polarization Scrambling

The MPC-203 includes several built-in polarization scrambling functions. Three of them (Triangle, Rayleigh, and Tornado) generate continuous SOP traces on the Poincaré sphere, while the fourth (Discrete) generates a sequence of randomly distributed, discrete SOPs. A fifth type (Trigger) performs discrete random-state generation in response to an external trigger signal rather than automatically at a set rate. These scrambling types are grouped under option 1 (Pol. Scrambling) on the main menu. When "Pol. Scrambling" is selected from the main menu, the display shows the scrambling control screen:

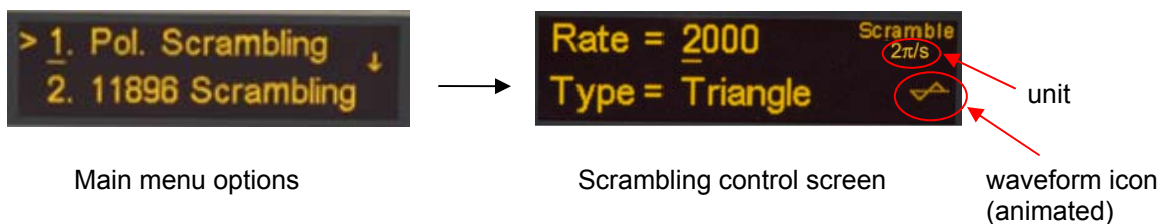

The scrambling control screen has two settable parameters: scrambling rate and scrambling type. To change the scrambling rate, use the ◀▶ buttons to move the cursor and rotate the wheel to change the value of the underlined digit. Press ENTER to switch to type selection. Either use the ◀▶ buttons or rotate the wheel to change the type setting. Both rate and type setting changes are applied in real time as the values are changed.

Scrambling is enabled by default, so as soon as the "Pol Scrambling" option is selected from the main menu, the MPC-203 will begin polarization scrambling, using the current scrambling type and rate settings. The default setting is triangle scrambling at rate = 0, so when the "Pol. Scrambling" option is first invoked after instrument power-on, the SOP will be static, but scrambling will begin as soon as the rate is changed to a nonzero value.

Scrambling Pause/Resume

In any of the scrambling modes, polarization scrambling can be paused, with the polarization controller remaining in the setting at which it was paused. When scrambling is resumed, the SOP variation will start from the point at which it was paused.

Press the thumb wheel to pause/resume scrambling.

MPC-203 User Guide

The animated waveform icon at the bottom right of the scrambling control screen indicates the scrambling pause/resume status. The icon moves when scrambling is enabled and stops moving when scrambling is paused.

Scrambling Types

The scrambling control screen includes three status indicators at the right of the screen. At the top, the word "Scramble" indicates that the MPC-203 is in scrambling mode. Immediately below it, the unit in which the scrambling rate is expressed for the active scrambling type is displayed:

Scrambling Type	Scrambling rate unit	Set value	Range
Triangle	Multiples of $2\pi/s$	Maximum rate of SOP variation	0.00 - 2000
Rayleigh	Rad/s	Mean of Rayleigh distribution	0.00 - 2000
Tornado	krad/s	Maximum rate of SOP variation	0 - 11010 1-10 in steps of 1 10-170 in steps of 10 170-11010 in steps of 20
Discrete	Points/s	# of points/s generated per second	0.00 - 20,000

At the bottom right of the screen is a small animated icon illustrating the current scrambling type. In the example above, the MPC-203 is in triangle scrambling, and the icon is a moving triangle wave. As noted above, this icon also indicates the scrambling pause/resume status: it moves while the instrument is scrambling, and stays still while scrambling is paused.

The scrambling types are described below, with their SOP variation patterns illustrated using a General Photonics polarimeter. The continuous trace scrambling types (Triangle, Rayleigh, and Tornado) will be described first.

Triangle

In triangle scrambling, the four channels of the polarization controller are driven with triangle-wave control signals at different frequencies. The frequencies are set by the scrambling algorithm such that the resultant continuous polarization trace evenly covers the Poincaré sphere. This function can be used for such applications as PDL measurement, in which the maximum and minimum light output power as a function of input polarization state is measured: for maximum accuracy, all polarization states need to be covered, but each power reading should be taken at a distinct polarization state. Since the photodetector in such a measurement often cannot follow a fast polarization scrambler, a function in which the polarization changes continuously allows the photodetector to average over states that are close to each other for each reading.



Figure 9 Triangle scrambling control screen

Figure 10 shows sample SOP traces for Triangle scrambling taken at different scrambling rates over the same capture period.

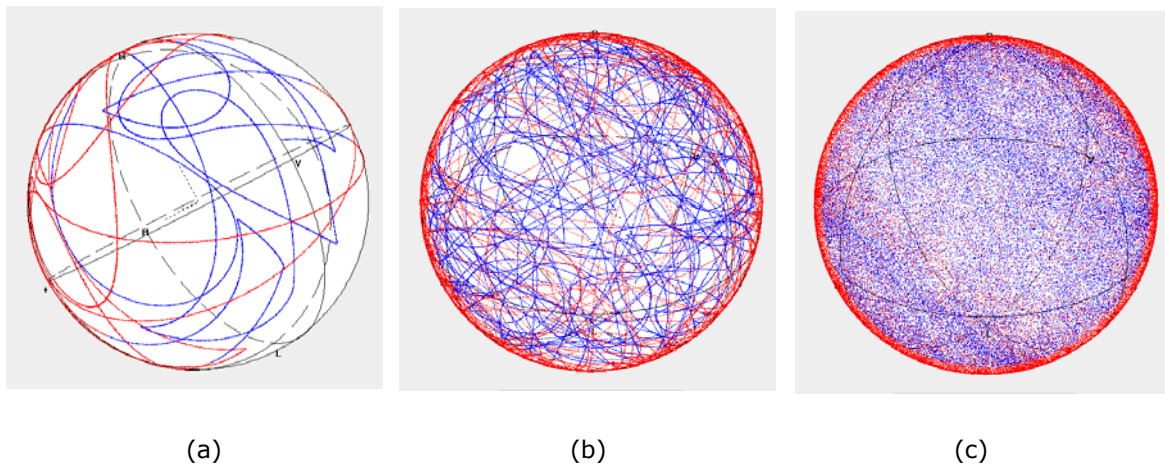

Figure 10 10-second SOP capture of triangle scrambling at rate = (a) $1 \times 2\pi/s$ (b) $10 \times 2\pi/s$, and (c) $100 \times 2\pi/s$.

Rayleigh

Rayleigh scrambling also produces a continuous SOP trace with even SOP distribution on the Poincaré sphere, but the rate of change of SOP (Δ SOP rate) follows a Rayleigh distribution, which emulates the SOP change rate in real fibers. Δ SOP is defined as the angle between two neighboring SOP points, measured from the center of the Poincaré sphere, and is measured in radians. The Δ SOP rate follows a Rayleigh distribution, independent of input SOP. Δ SOP rate distributions will be discussed in more detail later.



Figure 11 Rayleigh scrambling control screen

Figure 12 shows sample SOP traces for Rayleigh scrambling taken at different scrambling rates over the same capture period. Note that in the middle plot, dense lines indicate slower SOP movement and thinner lines indicate faster SOP movement.

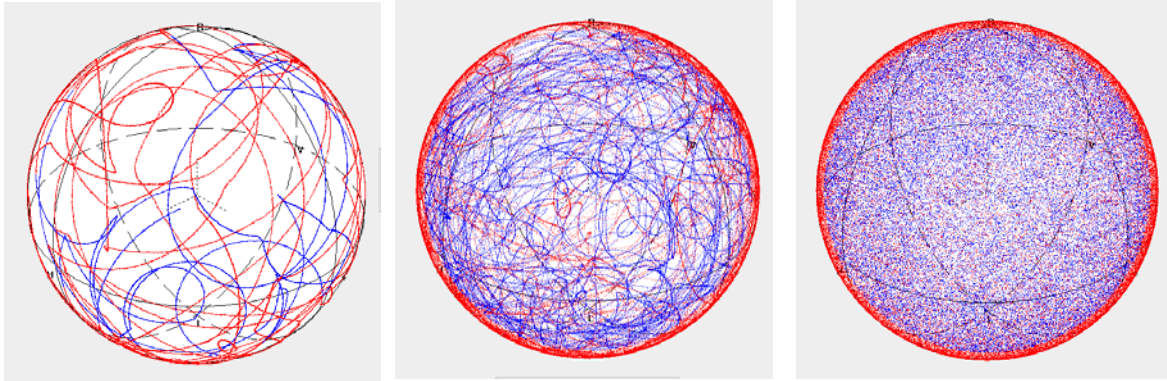

(a)

(b)

(c)

Figure 12 10-second capture of Rayleigh scrambling at (a) 10, (b) 100, and (c) 1000 rad/s mean SOP variation rate.

Tornado

Tornado scrambling generates a continuous trace on the sphere that consists of a series of back and forth arcs that move up and down the sphere. The size of the arcs varies with scrambling rate. Over time, the trace covers the entire sphere. The maximum SOP variation rate can be very high, which is useful in stress testing a device or an algorithm's polarization tracking capabilities. The user-set scrambling rate denotes the maximum SOP variation rate, in krad/s, that occurs at that setting. The SOP variation rate can vary depending on location on the sphere. The maximum value of ΔSOP occurs when the rotation is around the equator.

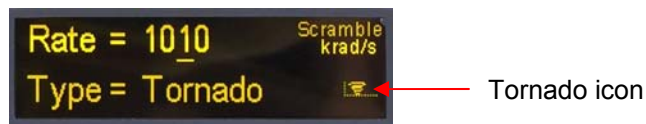

Figure 13 Tornado Scrambling control screen

The spin axis of the arcs can be either fixed or variable, as shown in Figure 14. If the spin axis remains fixed, the arcs move up and down the sphere along a straight line (Figure 14b). If the spin axis rotates, then the orientations, as well as the positions, of the arcs change over time (Figure 14a). Press the CH4 button to enable/disable the rotation of the spin axis. The animated tornado icon in the bottom right of the control screen indicates the axis-rotation status; if the axis is rotating, the tornado icon rotates from horizontal to vertical. If the axis is fixed, the icon remains vertical while moving from left to right. The default state is axis rotation enabled.

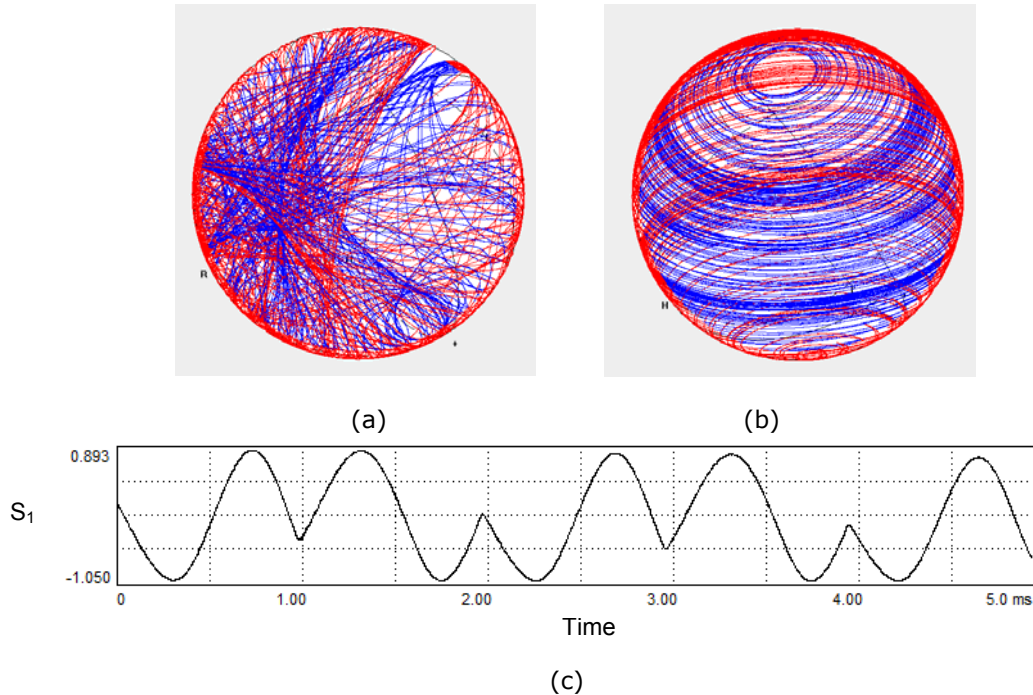

Figure 14 Illustrations of low-rate tornado scrambling regime: (a) 1.5 second SOP capture of tornado scrambling with rotating spin axis at 2 krad/s, (b) 1.5 second SOP capture of tornado scrambling with fixed spin axis at 2 krad/s. (c) S_1 vs time plot for tornado scrambling at 10 krad/s, measured using the oscilloscope mode of a General Photonics polarimeter. The measured periodicity is 1 ms per revolution.

The scrambling rate range for tornado scrambling is divided into 4 sections governed by different variations of the scrambling algorithm. The sections are:

- 1-10 krad/s
- 20-170 krad/s
- 190-2610 krad/s
- 2630-11010 krad/s

The correspondence between scrambling rate setting and maximum SOP variation rate is good in all regions. However, users may notice a slight transitional effect when changing the scrambling rate between different sections of the range.

MPC-203 User Guide

Differences between Tornado Settings in the MPC-203 and the MPC-201/2

In the MPC-203, the tornado mode scrambling rate setting corresponds to the maximum SOP rate of change that occurs at that setting.

In the MPC-202 and MPC-201, the tornado mode scrambling rate setting corresponds to the number of circles traced out on the Poincaré sphere per second. The maximum SOP rate of change occurs when the circle is traced around an equator of the sphere, so the maximum SOP rate of change in rad/s is $2\pi \times$ scrambling rate (in rev/s). The following table shows some representative values.

MPC-202 setting R_2 (rev/s)	MPC-203 setting R_3 (krad/s)	Max. SOP rate of change (krad/s)
		MPC-202: $\left(\frac{dSOP}{dt}\right)_{\max} = (2\pi \times R_2)/1000$ MPC-203: $\left(\frac{dSOP}{dt}\right)_{\max} = R_3$
1	NA	0.006
10	NA	0.063
50	NA	0.314
100	NA	0.628
159	1	1
1592	10	10
15915	100	100
33423	210	210
58887	370	370
NA	510	510
NA	1010	1010
NA	2010	2010
NA	5010	5010
NA	10010	10010
NA	11010	11010

As shown in the table, the MPC-202 provides finer tuning of the maximum SOP rate of change up to its maximum of 60,000 rev/s (\rightarrow 370 krad/s), while the MPC-203 can generate faster maximum SOP rate of change (up to \sim 11 Mrad/s).

Continuous Scrambling Rate Distributions

The different types of continuous scrambling have different Δ SOP rate distributions and are useful for different applications. As mentioned earlier, the Rayleigh distribution shown in Figure 15(a) most resembles the natural statistics in real fiber, and is therefore useful for emulation of fiber SOP variation. The Δ SOP rate distribution for Triangle scrambling is more uniform than the Rayleigh distribution, and is therefore more suitable for averaging out polarization effects, although the distribution is slightly input SOP dependent. Figure 15(b) shows the input-SOP-averaged Δ SOP rate distribution for triangle scrambling.

While the Rayleigh distribution always has the same shape, the Δ SOP rate distributions for Triangle and Tornado mode scrambling are somewhat input polarization dependent.

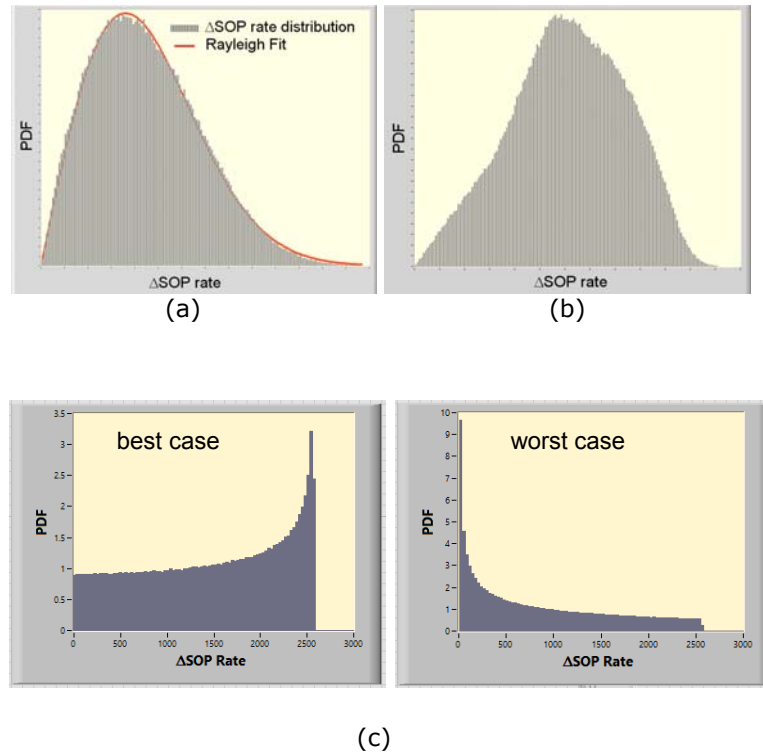

Figure 15 SOP variation rate distributions of (a) Rayleigh, (b) Triangle, and (c) Tornado scrambling. The Rayleigh distribution is input polarization independent. The Triangle distribution pictured is input polarization averaged. Best and worst-case distributions (depending on input polarization) are provided for Tornado scrambling.

Discrete

Discrete scrambling sends random combinations of drive voltages to the fiber squeezers, causing the polarization to make step changes to different random states at time intervals determined by the selected frequency. This pattern also generates even coverage of the Poincaré sphere, and can be used at high frequencies for applications requiring unpolarized light. Figure 17 shows SOP variation patterns taken at different scrambling rates over the same capture period.



Figure 16 Discrete Scrambling control screen.

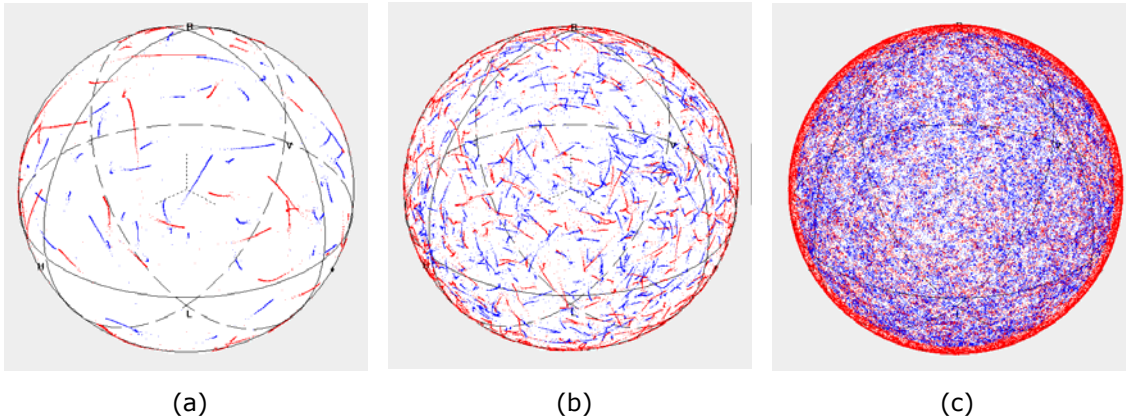

Figure 17 10 second SOP capture of discrete random scrambling at $f =$ (a) 10, (b) 100, and (c) 1000 points/s.

Output Trigger

When in discrete scrambling mode, the MPC-203 can send a TTL pulse synchronized with each output SOP change to the output trigger BNC connector on the rear panel. This output trigger signal can be used to synchronize to an external device.

The output trigger is disabled by default. To enable it, send the appropriate remote control command to the MPC-203 (See Table 1 through Table 5 in Appendix 1 for command lists, responses, and error codes). Other commands can be used to set up control parameters (pulse width, selection of rising or falling pulse) for the output trigger pulse. The pulse type can also be selected from the setup menu:

1. Pulse type setup for the output trigger signal:
 - From the main menu, select option 5 (setup).
 - Select Option 5e (trigger).

Trig (in)	Slope: Rising
Trig (out)	Slope: Rising

Trig (out) controls the output trigger. For the output trigger, "rising" means a rising pulse \square , and "falling" means a falling pulse \sqcap

MPC-203 User Guide

Trigger (Triggered Random SOP Generation)

The final operation mode under the “Pol. Scrambling” option on the main menu is triggered random state generation. The output polarization state updates one step to a different random state on receipt of each pulse from an external (input) trigger signal. This function can be used to synchronize with other equipment. One such application is in a recirculating loop experiment. To use this function:

1. Pulse edge setup for the external trigger signal:
 - From the main menu, select option 5 (setup).
 - Select Option 5e (trigger).

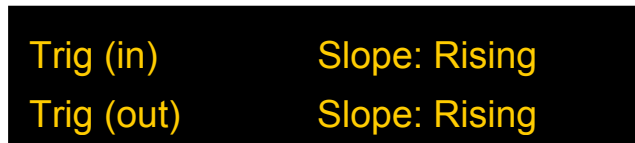

On the trigger control screen, set the MPC-203 to trigger on the rising or falling edge of the input trigger pulse (Trig in).

2. Connect external trigger (TTL signal) source to BNC connector on rear panel of MPC-203.
 - Minimum pulse width: 100ns
 - Threshold voltage for TTL high: 3.3V.
3. Select externally triggered random state generation:
 - From the main menu, select option 1 (Pol. Scrambling).
 - Set the Type to Trigger.

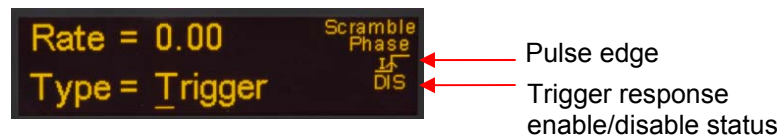

On this screen, the rate displayed will be 0.00, because the rate of random state generation depends on the interval between input trigger pulses.

The status indicators at the right of the screen show the pulse edge setting (trigger on rising edge of pulse, in the example above) and whether trigger response is enabled or disabled. When Trigger mode is entered using the front panel control, the trigger response should be enabled, but it can be disabled by remote control command. When trigger response is disabled, the MPC-203 will not respond to the input trigger.

11896 Scrambling

The 11896 Scrambling mode emulates the scrambling function of the discontinued Agilent 11896A polarization controller. It performs continuous-trace polarization scrambling at any of 8 speed settings.



Figure 18 11896 Scrambling control screen

Scan rate: Rotate the wheel to set the scan rate. Press ENTER to move the cursor to "Set Time".

Options: 1-8.

Set time: Use the ◀▶ keys to move the cursor and rotate the wheel to change the value of the active digit. Time is expressed in minutes:seconds.

Range: 0:00-99:59

Press ENTER to move the cursor to the scan status indicator.

Start the scan: The default status is "Paused". Rotate the wheel to change the status to "Restart", then press ENTER to begin scrambling. During scrambling, the "Run Time" indicator will count up to the set time. Once the set time is reached, scrambling will stop.

Pause/resume: During scrambling, pressing the wheel will pause/resume the scrambling operation. Scrambling resumes from the SOP at which it was paused.

With the cursor on the scan status indicator, scrambling can also be paused by rotating the wheel to change the status to "Paused" and pressing ENTER.

The scan status has 3 states: Paused, Run, and Restart. When a scan is paused, selecting "Run" will resume the scan currently in progress (the run time will start counting up from where it was paused. This is the same effect as pressing the thumb wheel to resume the scan.). Selecting "Restart" restarts the counter.

While the scan is paused, pressing ENTER moves the cursor to the scan rate setup position.

Note: There is no "unlimited time" setting for the 11896 scrambling function, but the Rayleigh scrambling function can be used to achieve the same effect. See the previous section for details on Rayleigh scrambling setup. The 11896 scrambling function uses the Rayleigh scrambling algorithm at the following settings.

MPC-203 User Guide

11896 Rate Setting	Rayleigh Rate Setting (rad/s)
8	25
7	20
6	17.5
5	9.375
4	5.25
3	3.125
2	2.125
1	0.85

Manual Polarization Control

This mode allows the user to convert any input polarization state into any desired output polarization state by tuning the DC control voltage signals to each fiber squeezer. Changing the voltage on each channel rotates the position of a point on the Poincaré sphere about some axis. Directions and some examples are given below.



Figure 19 Manual Polarization Control screen

Figure 19 shows the manual polarization control screen. The status indicators at the top right of the screen show, from top to bottom:

Active channel (fiber squeezer whose control signal is currently adjustable)

Amplitude units (control signal for each fiber squeezer can be expressed in terms of voltage, radians, or multiples of n radians).

Wavelength setting:

Since the voltage mapping used to express the amplitude in radians or multiples of n is wavelength dependent, it is important that the wavelength setting match the wavelength of the light source being used.

Both the wavelength setting and the amplitude unit setting can be changed from the Setup menu (main menu option 5). From the manual control screen, press the FUNC button to return to the main menu and select option 5 for setup. Once the setup is done, return to the manual polarization control screen by selecting option 3 from the main menu.

1. Select channel to be controlled using the Ch1-4 buttons. The cursor will move to the corresponding channel.

2. Use the ◀ ▶ buttons to move the cursor and rotate the wheel to change the value of the underlined digit. Ranges for each unit are:

Voltage: 0~150V

Phase retardation (n radians): 0~4 n phase retardation

Phase retardation (radians): 0~4 n phase retardation (=0 ~ 12.6 radians)

3. Repeat steps 1 and 2 to control other channels.

Figure 20(a) shows the change in polarization as the DC drive voltage on channel 1 of the polarization controller is increased from 0 to 2V n (V n for each channel is about 28V) with the voltage on the other channels remaining unchanged at 0V. Figure 20(b) to (d) show the corresponding cases for channels 2-4, respectively. As the voltage to each channel is increased, the point representing the input polarization is rotated about some axis, tracing out a circle on the Poincaré sphere.

MPC-203 User Guide

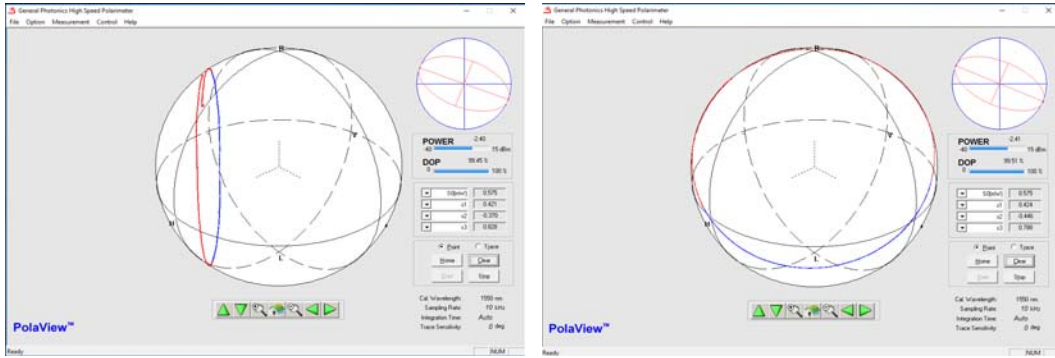

(a)

(b)

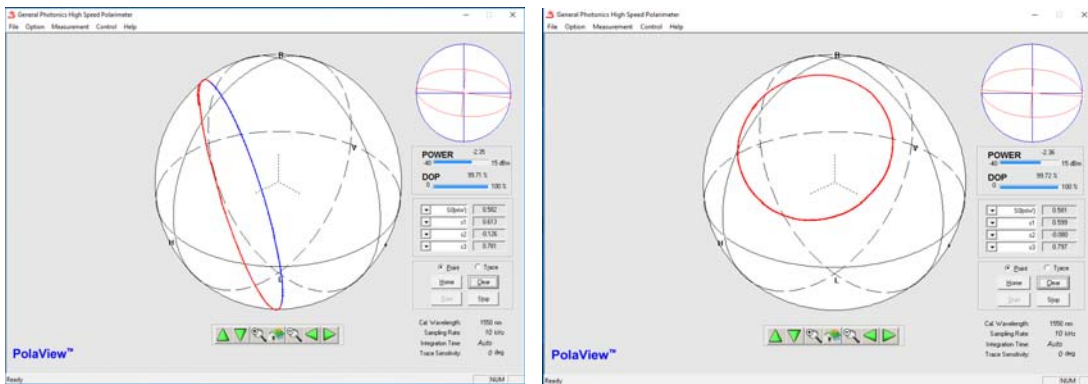

(c)

(d)

Figure 20 0 to 2Vn voltage increase applied to (a) channel 1. (b) channel 2. (c) channel 3. (d) channel 4.

Figure 21(a) shows the effects of increasing the voltage on channel 4 from 0 to 150V: the point makes more than 3 turns from its starting point A to its final state B.

Figure 21(b) illustrates one practical example of manual polarization control. A random input polarization state (point A) is changed to horizontal linear polarization at the output (point B) by sequentially adjusting the drive voltages to channels 1 and 2.

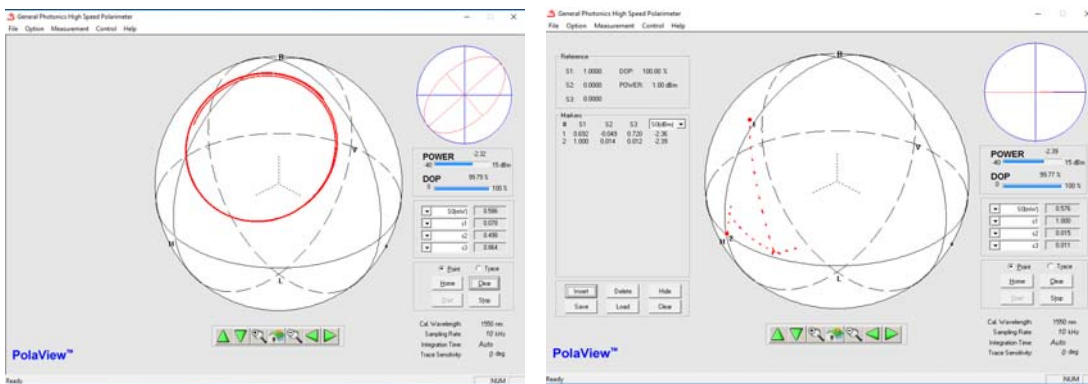

(a)

(b)

Figure 21 (a) 150V applied to channel 4. (b) Conversion of a random state to horizontal linear polarization

Polarization Modulation

In this mode, an internal function generator supplies the drive voltage signals to each of the four channels of the polarization controller. For each channel, the user can select a sine, triangle, or square waveform, and then set the frequency, amplitude, and offset for that waveform. Since the piezoelectric actuators require the application of positive voltages only, the amplitude setting is always less than the offset; as the amplitude is increased, the offset adjusts accordingly.

Figure 22 shows the polarization modulation control screen. The status indicators at the top right of the screen show, from top to bottom:

Active channel (fiber squeezer whose waveform parameters are currently displayed)

Amplitude or frequency units: The amplitude and offset of the waveform can be expressed in terms of voltage, radians, or multiples of n radians. The frequency is expressed in Hz. While the cursor is on the amplitude or offset, the unit indicator will display the currently selected amplitude unit. While the cursor is on the frequency, the unit indicator will display the frequency unit (Hz).

Animated waveform icon: The waveform icon indicates the waveform type (sine, square, or triangle), as well as the enable/disable state of the modulation.

Since the voltage mapping used to express the amplitude in radians or multiples of n is wavelength dependent, it is important that the wavelength setting match the wavelength of the light source being used.

Both the wavelength setting and the amplitude unit setting can be changed from the Setup menu (main menu option 5). From the modulation control screen, press the FUNC button to return to the main menu and select option 5 for setup. Once the setup is done, return to the modulation control screen by selecting option 4 from the main menu.

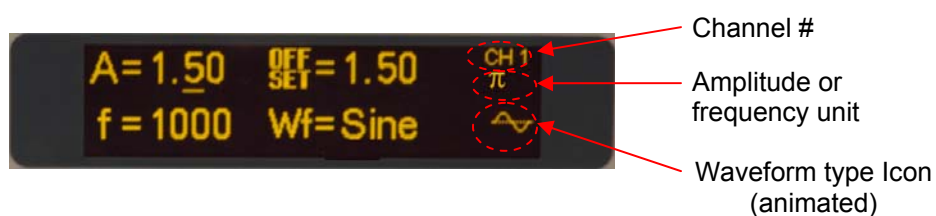

Figure 22 Polarization modulation control screen

1. Select channel to be controlled using the Ch1-4 buttons. The channel indicator in the upper right corner of the screen shows the active channel.
2. Press the ENTER button to toggle between amplitude (A), offset, frequency (f), and waveform type (Wf). The underscore indicates the selected parameter.
 - a. Amplitude, offset and frequency: Use the ◀ ▶ buttons to move the cursor and rotate the wheel to change the value of the underlined digit.

MPC-203 User Guide

	Voltage	n	Radians
Amplitude Range	0.0 to 45.0	0.0 to 1.5	0.0 to 4.71
Offset Range	A to (90 – A)	A to (3π – A)	A to (9.42– A)

Note that amplitude for this function works the way it does on a standard function generator. Therefore, $V_{pp} = 2A$, and an amplitude setting corresponding to V_n will result in a complete circle polarization trace for a sine or triangle wave.

Frequency range: 0~1000Hz

b. Waveform type: Use arrow buttons or thumb wheel to choose sine, triangle, or square wave. (The default is triangle wave.)

3. Repeat steps 1 and 2 to control other channels.

Waveform modulation is enabled by default, so as soon as the "Pol Modulation" option is selected from the main menu, the waveforms will be applied on all channels, using the current settings for each channel. The default setting is triangle modulation with all parameters set to 0, so when the "Pol. Modulation" option is first invoked after instrument power-on, the SOP will be static, but all changes to modulation parameters are applied in real-time as the value changes.

Waveform Pause/Resume

The pause/resume function for modulation works the same as in the polarization scrambling functions: modulation can be paused, with the polarization controller remaining in the setting at which it was paused. When modulation is resumed, the SOP variation will start from the point at which it was paused.

Press the thumb wheel to pause/resume modulation.

The animated waveform icon at the bottom right of the screen indicates the pause/resume status. The icon moves when modulation is enabled and stops moving when modulation is paused.

Waveform Examples

Applying a sine wave to one channel sweeps out a ring (or portion thereof, depending on the amplitude), sinusoidal in time, on the Poincaré sphere. Figure 23 shows examples of this for each of the 4 channels individually. Figure 23 (a) is the trace for a sine wave with amplitude 28V and frequency 5 Hz applied to channel 1. Figure 23 (b) is the same sine wave applied to channel 2. Figure 23 (c) shows the trace for a sine wave with amplitude 15V and frequency 5 Hz applied to channel 3, and Figure 23 (d) shows the trace for a sine wave with amplitude 20V and frequency 5 Hz applied to channel 4. Since V_n is about 28V, the first two traces sweep out close to a full ring, while the last two sweep out about half a ring.

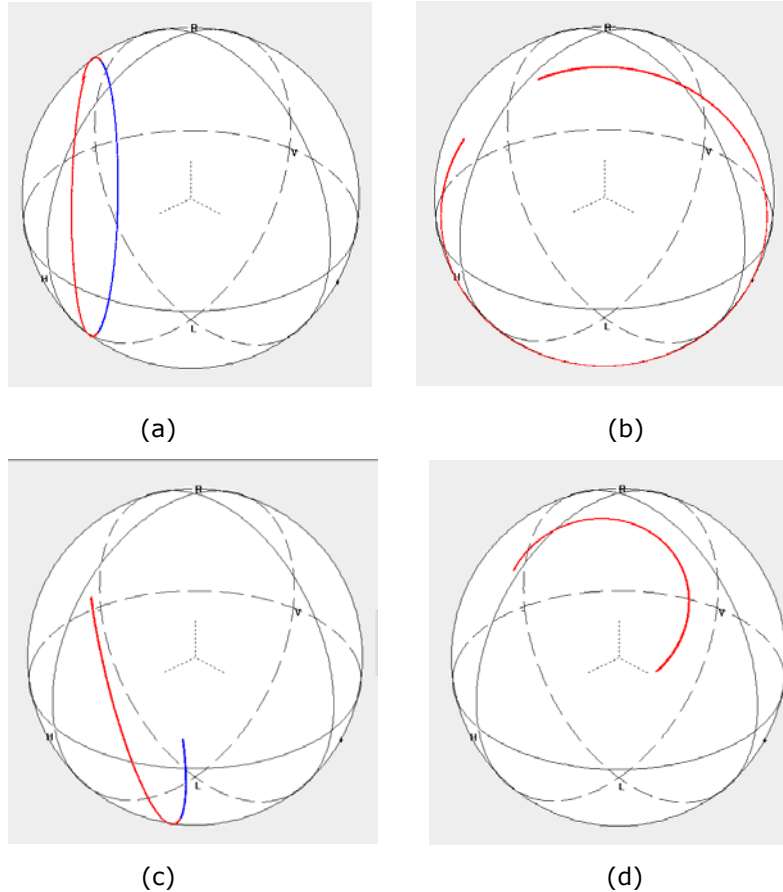

Figure 23 (a) Sine wave with $A=28V$, $f=5Hz$ on channel 1 (b) Sine wave with $A=28V$, $f=5Hz$ on channel 2 (c) Sine wave with $A=15V$, $f=5Hz$ on channel 3 (d) Sine wave with $A=20V$, $f=5Hz$ on channel 4.

A triangle wave applied to a single channel also sweeps out a ring (or portion thereof, depending on the amplitude) on the Poincaré sphere, but the polarization change along that path occurs at a constant speed set by the frequency. The final trace over several periods will look the same as that of a sine wave.

If a square wave is applied to a single channel, the polarization will switch periodically between two polarization states determined by the amplitude and offset settings of the wave. The frequency determines the dwell time at each polarization state. Figure 24 shows the trace for a square wave with amplitude 15V and frequency 5 Hz, applied to one of the channels. For clarity of illustration, the sampling settings of the polarimeter used to generate this figure were set such that only the two terminal SOP positions (and not the transition traces) were captured.

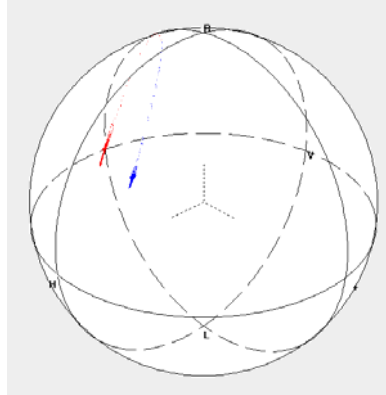

Figure 24 Square wave with $A=15V$, $f=5Hz$ on channel 1

If periodic waveforms are simultaneously applied to more than one channel, their effects are superposed, and the polarization state periodically sweeps out a more complicated pattern on the Poincaré sphere. Certain frequency combinations will cover the entire sphere. This can be a basis for polarization scrambling. Figure 25(a)-(d) show some examples.

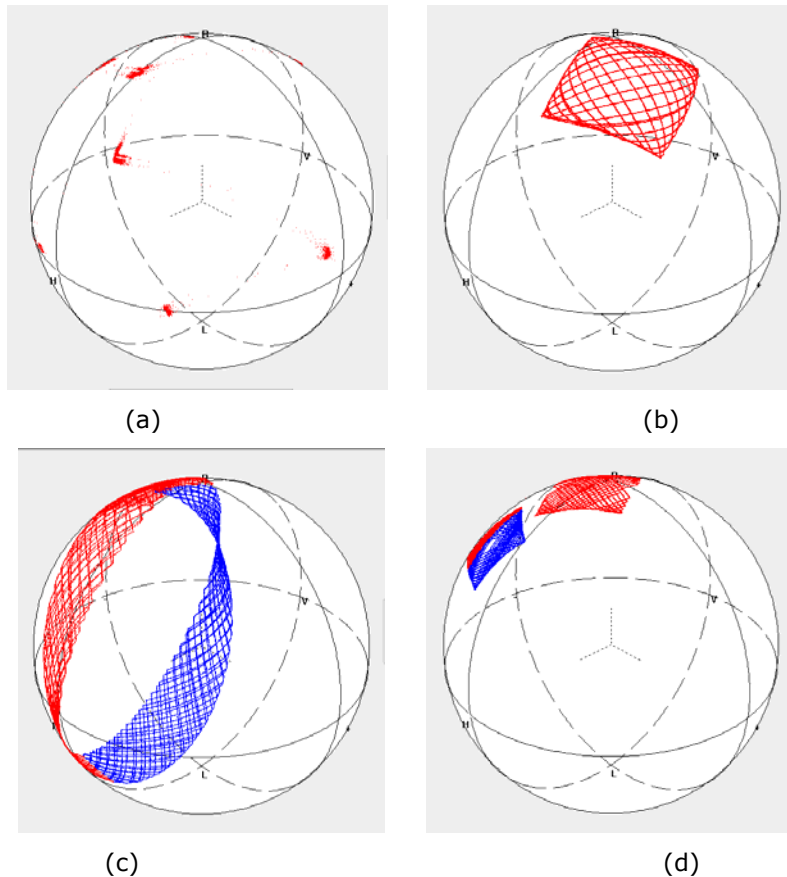



Figure 25
 (a) square wave with $A=7.5V$, $f=1Hz$ on channel 1, square wave with $A=7.5V$, $f=2Hz$ on channel 2, Square wave with $A=7.5V$, $f=3$ on channel 3
 (b) Sine wave with $A=4V$, $f=1Hz$ on channel 1, Sine wave with $A=4V$, $f=1.1Hz$ on channel 2.
 (c) Triangle wave with $A=30V$, $f=1.1Hz$ on ch 1, Triangle wave with $A=3V$, $f=11.3Hz$ on ch. 2
 (d) Sine wave with $A=3V$, $f=3Hz$ on channel 1, Triangle wave with $A=3V$, $f=3.1Hz$ on channel 2, Square wave with $A=7.5V$, $f=0.2Hz$ on channel 3.

Output Trigger

The MPC-203 can send a TTL pulse synchronized with the waveform on a particular channel to the output trigger BNC connector on the rear panel. This output trigger signal can be used to synchronize to an external device.

The output trigger is disabled by default. It can be enabled via remote control command (See Table 1 through Table 5 in Appendix 1 for command lists, responses, and error codes). Other commands can be used to set up control parameters (pulse width, etc.) for the output trigger pulse. The pulse type (rising/falling) selection can also be set from the setup menu (main menu option 5).

Output trigger setup parameters:

Channel:	Output trigger synchronizes with waveform on selected channel. Options: 1-4
Pulse Type	Options: rising pulse  , falling pulse  Default: Falling
Position	Synchronize trigger pulse with selected extremum of waveform. Options: Max, Min, Zero. (Note: Min and Zero have the same effect) Default: Zero
Pulse width	Width of trigger pulse Range: 0-65535 μ s Default: 25 μ s
Enable/Disable status	Default: Disabled

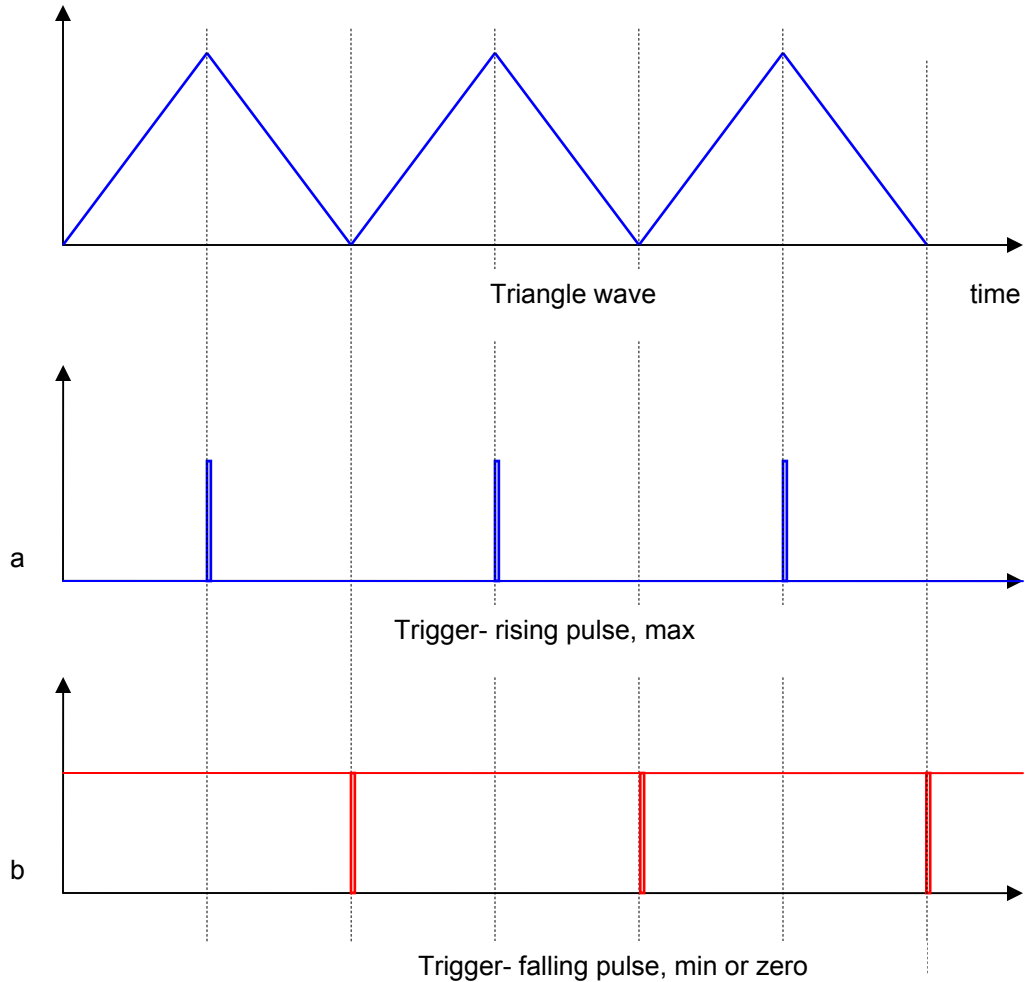

Figure 26 Output trigger examples

Figure 26 illustrates how the output trigger works with different setup parameters. This example uses a triangle waveform on one channel. In plot (a), the output trigger setup is pulse type: rising, position: max. A rising trigger pulse is sent when the waveform reaches its maximum point. In plot (b), the output trigger setup is pulse type: falling, position: min. A falling trigger pulse is sent when the waveform reaches its minimum point.

System Setup

The system setup menu (option 5 in the mode selection menu) allows the user to set up several operation parameters (see items a-i under "system setup" in the menu tree in Figure 8). These setup parameters are written to nonvolatile memory and will be retained after power-off.

From the initial setup option screen, use the wheel or arrow keys to move between options and the ENTER key to select an option to set the desired operation parameter.

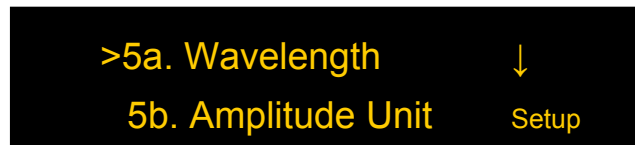

Wavelength:

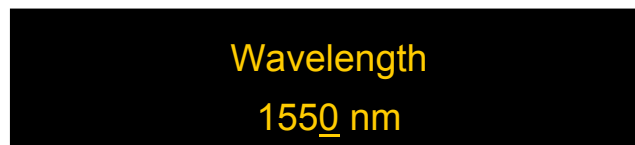

This option selects the operation wavelength for the MPC-203.

Range: 1260-1650nm for standard version

Default Value 1550nm

Use the ◀▶ keys to move the cursor and rotate the wheel to change the value of the underlined digit. The wavelength setting updates in real time as the value is changed.

When finished setting the wavelength, press the FUNC key once to return to the setup option menu or twice to return to the main menu.

Amplitude Units:

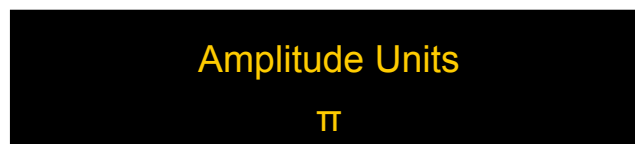

This option sets the units used to express the magnitude of the control signal applied to each fiber squeezer. The selected unit is used for the control signal magnitudes in manual control mode, and for the waveform amplitudes in polarization modulation mode. Amplitude can be

MPC-203 User Guide

expressed in terms of the control voltage applied to the squeezers. The voltage to phase retardance of each fiber waveplate is also mapped out such that the amplitude can be displayed in units of radians, or in multiples of n radians. The phase retardance is factory calibrated to within 5% accuracy. Since phase retardance is wavelength dependent, it is important to specify the correct operating wavelength to ensure accurate results.

Available options: multiples of n
 Radians
 Voltage
Default value: n

Rotate the wheel to select the desired amplitude unit. The setting updates in real time as the value is changed.

When finished, press the FUNC key once to return to the setup option menu or twice to return to the main menu.

Comm Type:

Command Type
SCPI

The MPC-203 has two available remote control command formats: SCPI, and a legacy format for users who may have control programs written for the MPC-101 that they may wish to use with the MPC-203.

This option allows the user to set the MPC-203 to respond to a particular command format.

Options: SCPI, GP
Default: SCPI

Rotate the wheel to toggle between SCPI and GP.

When finished, press the FUNC key once to return to the setup option menu or twice to return to the main menu.

Comm EOS:

Command EOS
CR + LF

This option allows the user to select the end-of-string indicator for SCPI commands.

Options: CR + LF
CR (= carriage return)
LF (= line feed)
Default: CR + LF

Rotate the wheel to change the end-of-string indicator setting. The setting updates in real time as the value is changed.

When finished, press the FUNC key once to return to the setup option menu or twice to return to the main menu.

Trigger:

Trig (in) Slope: Rising
Trig (out) Slope: Rising

This option selects the pulse edge setting for the input trigger signal and the pulse type setting for the output trigger signal.

Options: Rising, Falling
Default: Falling

Rotate the wheel to toggle between rising and falling settings on the current line, and use the ENTER key to toggle between the input and output trigger setting lines.

When finished, press the FUNC key once to return to the setup option menu or twice to return to the main menu.

GPIB Address:



A black rectangular box with yellow text that reads "GPIB Address = 5".

This option sets the instrument's GPIB address.

Range: 1-30

Default: 5

Rotate the wheel to change the GPIB address. The GPIB address changes in real time as the value is changed.

When finished, press the FUNC key once to return to the setup option menu or twice to return to the main menu.

Dynamic IP address:

The instrument's IP address must be known in order to control it via Ethernet.

See Appendix 4 for Ethernet setup details.

The "Dynamic IP" option sets the instrument for dynamic IP addressing and requests a dynamic IP address from the server.

From the Setup menu, select "Dynamic IP", then press the ENTER key to request a dynamic IP address from the server.

If the instrument is able to establish communication with the DHCP server and successfully retrieve an IP address, the address will be displayed on-screen.



A black rectangular box with yellow text that reads "Dynamic IP Address 192.168.2.150".

If the instrument is unable to connect to the server, it may display 0.0.0.0. In this case, first, check the connection. If the connections are correctly set up, press the ENTER key to re-send the request.

When finished, press the FUNC key once to return to the setup option menu or twice to return to the main menu

MPC-203 User Guide

Each time this menu option is selected, the instrument requests a dynamic IP address from the server. If this menu option is selected while the instrument is already in communication using a dynamic IP address, the instrument may be assigned a dynamic IP address other than the one it is currently using. This may interrupt communication, and the address may not be displayed correctly on the front panel.

Static IP address:

Selecting "Static IP" sets the instrument for Ethernet communication using static IP addressing and allows the user to set the static IP address, Net Mask, Gateway, and Name Server. The setup screens for this option are as follows:

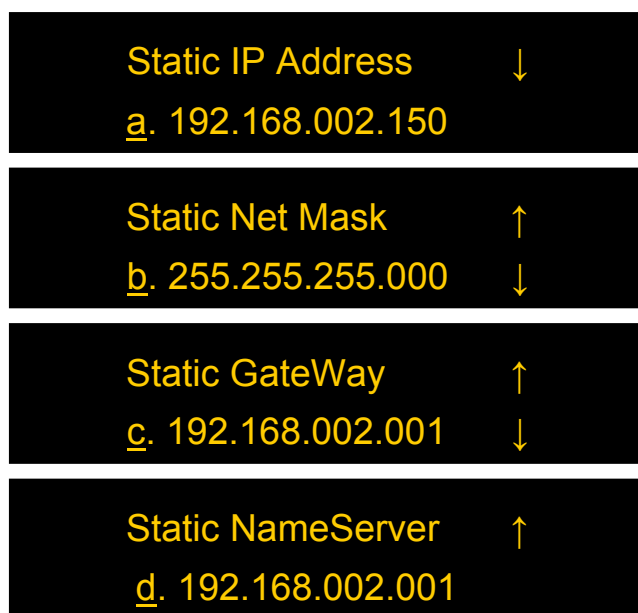

Rotate the wheel to move between static IP setup parameter options when the cursor is on the setup parameter index (a-d).

Press the ENTER or ► keys to move to setup for the currently selected parameter.

To set a particular parameter, use the ◀▶ buttons to move the cursor position and rotate the wheel to change the value of the active digit. Once the parameter is set, press ENTER to move the cursor position back to the parameter index (a-d).

When finished, press the FUNC key once to return to the setup option menu or twice to return to the main menu.

RS-232 Setup:

Baud Rate
9600

This option allows the user to set the baud rate for RS-232 communication.

Options: 110, 300, 600, 1200, 2400, 4800, 9600, 19200, 28800, 38400, 43000,
56000, 57600

Default: 9600

Rotate the wheel to change the baud rate setting. The setting updates in real time as the value is changed.

When finished, press the FUNC key once to return to the setup option menu or twice to return to the main menu.

System Reset

Selecting this option from the main menu reinitializes the instrument and resets all of the operation parameters to their default values.

3.4 Troubleshooting

The performance of the MPC-203 can be tested using a polarized light source and a fast polarimeter.

Front Panel

1. To ensure a stable output SOP, place the setup on a stable surface and fix SM fibers in place.
2. For proper scrambling performance, do not interchange the input and output connectors.

Remote Control

Command Format

1. Make sure the "Command Type" setting (SCPI or GP) matches the format of the actual command format to be used.
2. SCPI format: Command strings without an end-of-string (EOS) character will not be executed. Make sure that the "Command EOS" setting matches the EOS being used.
3. GP format: If the beginning ("*") or ending identifiers ("#" or "?") of a command are missing, the instrument will not respond.
4. The instrument will beep to indicate an improperly received command or other error.

RS-232

1. Make sure that the cable is straight-wired (pin-to-to pin wired) not cross-wired.
2. Verify active Comm Port (COM1, COM2, etc.).
3. Verify Comm Port settings: 8 data bits, 1 stop bit, no parity bits.
4. Make sure baud rate setting on instrument matches baud rate being used by control computer.

USB

1. Make sure that the USB driver is installed before communicating via USB.

Ethernet

1. Make sure that the Ethernet communication setting (Static or Dynamic) matches the Ethernet addressing type being used.
2. Make sure that the cable type is correct: cross-linked cable for direct connection static IP, straight-linked cable for dynamic IP.
3. Every time "Dynamic IP" is selected from the Settings menu, the instrument requests a new dynamic IP address from the server. If this happens while the instrument is already in communication via dynamic IP, the communication may be interrupted.

MPC-203 User Guide

Section 4.0 Specifications

Optical

Operating wavelength range	1260-1620 nm or 980-1310nm
Power Handling	0-1000 mW
Insertion Loss	<0.15 dB intrinsic <0.6 dB with connectors
Return Loss	>50 dB with connectors
PDL	<0.1 dB with connectors
PMD	<0.2 ps with connectors
Activation Loss	<0.1 dB

Electrical/Communication

Front panel display	OLED graphic display
Power Supply	100-240VAC, 50-60 Hz
Input/Output Triggers	TTL pulse, BNC connector
Communication Interfaces	RS-232, USB, Ethernet, GPIB
GPIB Address	1-30
RS-232 Baud Rate	110, 300, 600, 1200, 2400, 4800, 9600, 19200, 28800, 38400, 43000, 56000, 57600

Physical and Environmental

Dimensions	2U $\frac{3}{4}$ 19" rack width 14" (L) × 14" (W) × 3.5" (H)
Fiber Type	Single mode fiber
Fiber Input/Output Connectors	FC/PC, FC/APC, SC/PC, SC/APC
Weight	10.6 lb
Operation temperature	0 to 50°C
Storage Temperature	-20 to 70°C

System

Polarization Scrambler

Scrambling Types	Continuous trace	Tornado, Rayleigh, Triangle, 11896A emulation
	Discrete SOPs	Random, Triggered Random
Scrambling Rate	Tornado	0 to 11010 krad/s (max SOP variation rate)
	Rayleigh	0 to 2000 rad/s (mean SOP variation rate)
	Triangle	0 to 2000 × 2π rad/s (max SOP variation rate)

MPC-203 User Guide

	Agilent 11896A emulation	8 scan rates, matched to same settings on Agilent 11896A Set time: Variable to 99 min, 59 sec.
	Discrete	0 to 20,000 points/s
	Triggered Random	1 random SOP per input trigger pulse (TTL) Maximum frequency: 20,000 points/s Trigger on rising or falling edge (user selectable)
Output Trigger Pulse	Discrete Mode	1 output TTL pulse per SOP generated Pulse width: 1-65535 μ s, user selectable Pulse type: rising or falling, user selectable

Polarization Control

SOP mapping	Arbitrary- convert any input SOP to any output SOP
SOP control	4 independently addressable channels
SOP tuning range	4n retardation per channel (or 0-150V control voltage range)

Polarization Modulation (function generator)

Modulation Control	Single channel or independent multi-channel waveform control
Amplitude	0.00 to 1.5n rad (peak to peak variation = 2 \times Amplitude)
Offset	Amplitude < Offset < 3n–Amplitude
Frequency	0.00 to 1000 Hz
Waveforms	Sine, Triangle, Square
Output Trigger	1 output TTL pulse per cycle on selected channel Options: Trigger at max, min, or zero of waveform Pulse width: 1-65535 μ s, user selectable Pulse type: rising or falling, user selectable

Notes:

Specifications listed in table apply for standard 1260-1620nm operation at 23 \pm 5°C.

WARRANTY

All of General Photonics' products have been inspected and found to comply with our quality assurance standards before shipping. If any damage occurs during shipment, please contact the carrier and inform us or your distributor as soon as possible.

Do not attempt repair of any General Photonics product. Repair of defective products must be performed by factory trained engineers.

General Photonics warrants that this product will be free from defects in materials or workmanship for a period of one year from the date of shipment. A product found to be defective during the warranty period will be repaired or replaced, at no charge, at General Photonics' option.

If a problem is found, please contact General Photonics for assistance and instructions for any necessary returns.

General Photonics Customer Service
T: 909-590-5473
Email: support@generalphotonics.com
www.generalphotonics.com

You will be provided with a problem report form. Please complete the form with as complete a description of the problem and the conditions under which it occurred as possible. If the product is found to require factory repair, General Photonics will issue an RMA number for the return. Please label the product clearly with the RMA number. Failure to follow this procedure may delay the evaluation and repair of the product.

The above warranty specifically excludes products that have been repaired or modified by non-manufacturer-authorized personnel, products with a broken warranty seal or opened enclosure, and damage caused by misuse, abuse, improper storage or handling, or acts of nature. This warranty is in lieu of all other warranties, expressed or implied. General Photonics will not be liable for any indirect or consequential damages or losses resulting from the use of its products.

Appendices

The following appendices include the remote control command lists, as well as setup information for different control interfaces.

Appendix 1.0 Remote Control Commands

The commands and responses listed in Table 1, Table 2, and Table 4 are the same for all communication protocols: RS-232, USB, Ethernet, and GPIB.

Once the MPC-203 receives a command, it goes into remote control mode, and the front panel keypad is locked. A small LCL indicator will appear on the front panel display. Press ENTER to return to front panel control. The indicator will disappear once front panel control is restored.

The MPC-203 needs to be set to respond to a particular command format before it can receive commands. Use the "Comm Type" setup screen under "System Setup" to select SCPI or GP format before sending commands.

For SCPI commands, multiple commands can be concatenated in one string, using semicolons as separators, up to a limit of 128 characters per string.

For GP format commands, only one command string can be sent at a time.

If the MPC-203 beeps after receiving a command, that indicates that there was a problem with the command. Typically, this happens if the command was incorrectly formatted, or does not match the control mode (for example, if the MPC-203 is in GP command mode, and an SCPI command is sent).

Command Lists

SCPI Commands

SCPI command notes:

1. Each command sequence can be queried by using "?" in place of set parameters to check the command's current parameter settings. There is no space between the command sequence and "?".
2. There is a space between a command sequence and a set parameter. Settable parameters are listed in the table using triangular brackets < >.
3. Command segments listed in the table in square brackets [] are optional; they are included for human interpretability.
4. Many command segments can be written out as full words or in pre-defined abbreviated forms consisting of 3 or 4 letters. The abbreviated commands are capitalized in the command sequences listed in the table. E.g. the firmware version query command can be written out as either :SYSTEM:VERSion? or :SYST:VERS?
5. Multiple command strings can be concatenated using a semicolon ";".

MPC-203 User Guide

6. An end-of-string (EOS) is required to execute a complete command string, the EOS can be configured as Line Feed (LF), Carriage Return (CR), or both (LF+CR).
7. If the MPC-203 beeps after a command is sent, check the MPC's command type setting (GP or SCPI) and EOS setting to make sure they match the format of the command being sent. Also, check that the command is correctly formatted before resending.
- 8. If the instrument does not carry out a command and does not beep, it may not have received the EOS character. Make sure that the command string ends with the correct EOS. The default EOS is CR + LF (0D 0A in HEX)**

Table 1 SCPI Remote Control Command List

Command Sequence	Parameters	Description/Example
<i>System Information</i>		
:SYSTem:ERRor?		Return error sequence, 20 error messages max, errors read out in FIFO sequence.
:SYSTem:VERSion?		Query firmware version: return value <string> (e.g. 1.0.1-20111216A)
<i>Communication</i>		
:SYSTem:COMMunicate:EOS	<LF CR CR+LF>	Set/query End Of String type for SCPI :SYST:COMM:EOS CR+LF
:SYSTem:COMMunicate:HSHake	<ON OFF>	Set/query handshake enable/disable status. :SYST:COMM:HSH ON
:SYSTem:GPIB:ADDRess	< integer >	Set/query GPIB address, range: 1 to 30. :SYST:GPIB:ADDR 10
:SYSTem:NET:IP	<string>	Set/query IP address. :SYST:NET:IP 192.168.1.122
:SYSTem:NET:MASK	<string>	Set/query net mask. :SYST:NE:MASK 255.255.255.0
:SYSTem:NET:GWAY	<string>	Set/query gateway address. :SYST:NET:GWAY 192.168.1.1
:SYSTem:NET:NSERver	<string>	Set/query nameserver. :SYST:NET:NSER 206.13.30.12
:SYSTem:NET:MODE	< SIP DHCP >	Set/query Ethernet mode (Static or Dynamic) :SYST:NET:MODE DHCP
:SYSTem:SERial:BAUDrate	0~12	Set/query RS-232 baud rate. 0: 110; 1: 300; 2: 600; 3: 1200; 4: 2400; 5: 4800; 6: 9600; 7: 19200 8: 28800; 9: 38400; 10: 43000; 11: 56000; 12: 57600 :SYST:SER:BAUD 6

Note: NET commands (IP, MASK, GWAY, NSERver) are used to set parameters for static IP addressing. However, the query versions will return values for either static or dynamic IP depending on MODE setting.

<i>Manual Polarization Control</i>		
[:INPut]:CHANnel(n)[:DC]	< float>[unit]	Set/query DC voltage for Channel n. Unit = V, PI, or RAD. If unit not specified, uses default unit (V). Range: 0 to 150 V 0 to 4 pi 0 to 12.6 rad Ex: :INP:CHAN1:DC 8.8V or :CHAN1 8.8 :INP:CHAN1:DC 1PI or :CHAN1 1PI

MPC-203 User Guide

<i>Polarization Modulation</i>		
[:INPut]:CHANnel(n):WAVEform:TYPE	< SIN TRIangle SQUARE>	Set/query waveform type. :CHAN2:WAV:TYPE SIN
[:INPut]:CHANnel(n):WAVEform:AMPLitude	< float>[unit]	Set/query amplitude value. Unit: V, PI, or RAD. Range: 0 to 45 unit=V 0 to 1.5 unit=PI 0 to 4.71 unit=RAD :CHAN2:WAV:AMPL 8.8V
[:INPut]:CHANnel(n):WAVEform:FREQuency	< float>	Set/query frequency value, in Hz. Range: 0.01 to 1000 :CHAN2:WAV:FREQ 888
[:INPut]:CHANnel(n):WAVEform:OFFSet	< float>[unit]	Set/query amplitude offset value. Unit: V, PI, or RAD. Range: refer to table on p. 30 :CHAN2:WAV:OFFS 8.8V
[:INPut]:CHANnel(n):WAVEform:PHASe	< float>	Set/query amount of phase shift, in degrees; range: 0 to 360. :CHAN2:WAV:PHAS 88.8
[:INPut]:CHANnel(n):WAVEform:STATe	< ON OFF >	Start or pause waveform on specific channel :CHAN2:WAV:STAT ON
[:INPut]:CHANnel(n):WAVEform:REStart		Restart waveform on a specific channel :CHAN2:WAV:REST
<i>Polarization Scrambling</i>		
[:INPut]:[:SCRamble]:DISCrete:RATE	< float>	Set/query discrete scrambling rate, points/s Range: 0.01 to 20000 :DISC:RATE 188
[:INPut]:[:SCRamble]:DISCrete:STATe	< ON OFF >	Start or pause discrete scrambling. :DISC:STAT ON
[:INPut]:[:SCRamble]:TRIangle:RATE	< float>	Set/query triangle scrambling rate in multiples of 2n radians/s. Range: 0.01 to 2000 :TRI:RATE 188
[:INPut]:[:SCRamble]:TRIangle:STATe	<ON OFF>	Start or pause triangle scrambling. :TRI:STAT ON
[:INPut]:[:SCRamble]:RAYLeigh:RATE	< float>[unit]	Set/query Rayleigh scrambling rate (mean of distribution, in rad/s). Range: 0.01 to 2000 :RAYL:RATE 88.8
[:INPut]:[:SCRamble]:RAYLeigh:STATe	< ON OFF >	Start or pause Rayleigh scrambling. :RAYL:STAT ON
[:INPut]:[:SCRamble]:TORNado:RATE	<float>	Set/query Tornado scrambling rate (max rate in distribution, in krad/s) Range: 0 to 11010 0-10 in steps of 1 10-170 in steps of 10 170-11010 in steps of 20 (e.g. 1,2,3...10, 20, 30....170, 190...) Rate is rounded to nearest viable setting. :TORN:RATE 1010
[:INPut]:[:SCRamble]:TORNado:STATe	<ON OFF>	Start or pause Tornado scrambling :TORN:STAT ON
[:INPut]:[:SCRamble]:TORNado:TYPE	<0 1>	Set/query Tornado rotation axis status. 0: fixed rotation axis 1: moving rotation axis :TORN:TYPE 0
<i>Agilent Model 11896 emulator</i>		
:INITiate:IMMEDIATE		Restart Agilent scrambling emulation :INIT:IMM
:SCAN:RATE	<id>	Set/query scan rate setting. scan rate range: 1 to 8 :SCAN:RATE 8

MPC-203 User Guide

:SCAN:TIMer	<MIN:SEC>	Set/query scan time length setting. Range: 0:00 to 99:59 :SCAN:TIM 8:30
:SCAN:TIMer:CLEar		Clear set time :SCAN:TIM:CLE

<i>Trigger Menu</i>		
:TRIGger:INPut:STATe	< ON OFF >	Enable/disable input trigger. default: <OFF> :TRIG:INP:STAT ON
:TRIGger:INPut:TYPE	< REDGe FEDGe>	Set/query input trigger edge type: rising or falling edge. Default: Falling edge. :TRIG:INP:TYPE REDG
:TRIGger:INPut:COUNter:VALue?		Query TRIGGER input counter
:TRIGger:INPut:COUNter:CLS		Clear TRIGGER input counter
:TRIGger:OUTPut:STATe	< ON OFF>	Enable/disable output trigger. default: OFF :TRIG:OUTP:STAT ON
:TRIGger:OUTPut:TYPE	< REDGe FEDGe>	Set/query output trigger type: Rising/Falling pulse. Default: Falling pulse :TRIG:OUTP:TYPE REDG
:TRIGger:OUTPut:COUNter:VALue?		Query TRIGGER output counter
:TRIGger:OUTPut:COUNter:CLS		Clear TRIGGER output counter
:TRIGger:OUTPut:PWIDth	< integer >	Set/query TRIGGER output pulse width , Range: 0-65535 μ s default: 25 μ s. :TRIG:OUTP:PWID 8888
:TRIGger:OUTPut:CHANnel(n)	< MAX MIN ZERO>	Set/query trigger output position for channel n: minimum or maximum point of waveform. Note: min and zero have the same effect. Default: zero. :TRIG:OUTP:CHAN1 MAX

<i>System Setting</i>		
:DISPlay:LOCK	< ON OFF>	ON: OLED displays "REMOTE CONTROL." OFF: OLED displays current function. :DISP:LOCK ON
:CONFigure:WLENGth	< float>	Set/query operation wavelength in units of nm. Range: 1260 to 1650 :CONF:WLEN 1550.0
:UNIT:DC	< V RAD PI >	Set/query units used for control signal magnitude in manual polarization control (DC), and for AMPLitude and OFFSet for waveforms. Default unit: V :UNIT:DC RAD
:ABORt		Stop current function
:PAUSE		Pause current function
:REStart		Restart current function
:STATus:MODE?		Query current system mode: 0: Discrete scrambling 1: Triangle scrambling 2: Rayleigh scrambling 3: Trigger-in scrambling 4: Tornado scrambling 5: Agilent scrambling 6: Polarization modulation 7: Polarization manual control 8: System Setup menu screen
:STATus:QUESTion:EVENT?		Query questionable event register; returns integer within range 0 ~ 65535 (16 bits) Reading the register clears all bits.
:STATus:QUESTion:CONDition?		Query questionable condition register. 0 = disable, 1 = enable

MPC-203 User Guide

:STATus:QUESTion:ENABLE	0 ~ 65535 (16 bits)	Set enable/disable status of all bits of questionable event enable register. 0 = disable, 1 = enable Or query questionable event enable register. :STAT:QUES:ENAB 888
:STATus:OPERation:EVENT?		Query operation event register
:STATus:OPERation:CONDition?		Query operation condition register.
:STATus:OPERation:ENABLE	0 ~ 65535 (16 bits)	Set enable/disable status of all bits of operation event enable register. 0 = disable, 1 = enable Or query operation event enable register. :STAT:OPER:ENAB 888

Sample commands:

1. Set MPC to Rayleigh scrambling mode with mean Δ SOP rate of 100rad/s, and start running.
:INP:SCR:RAYL:RATE 100;;INP:SCR:RAYL:STAT ON
2. Set MPC to waveform mode, with sinusoidal waveform on channel 1, 20V amplitude, 30Hz frequency, and start running.
:CHAN1:WAV:TYPE SIN;;CHAN1:WAV:AMPL 20 V;;CHAN1:WAV:FREQ 30;;CHAN1:WAV:STAT ON
3. Set MPC units to Volts, and then set channel 1 to 10V and channel 2 to 20V in manual mode.
:UNIT:DC V;;CHAN1 10V;;CHAN2 20V
4. Query waveform type on Channel 3.
:INPut:CHANnel3:WAVEform:TYPE?

Table 2 SCPI Common Commands and Queries (GPIB specific)

These commands are common to all GPIB-enabled devices.

Command	Parameters	Response	Description
*IDN?	n/a	<company >, <model>, <serial>, <firmware ver>	The Identification query outputs an identifying string.
*RST	n/a	n/a	Resets most functions to factory-defined conditions. Each command shows *RST value if the setting is affected.
*TST?	n/a	0 or 1	This command queries the internal self-test when system initiates and returns a result. (0) All tests passed. (1) One or more tests failed.
*ESE	<data> (Range: 0-255)	n/a	Selects the desired bits from the standard Event Status Enable register. The variable <data> represents the sum of the bits that will be enabled. This register monitors I/O errors and synchronization conditions such as operation complete, request control, query error, device dependent error, status execution error, command error and power on. The selected bits are OR'd to become a summary bit (bit 5) in the byte register which can be queried. The setting by this command is not affected by the *RST.
*ESE?	n/a	0 or 1	The Standard Event Status Enable query returns the value of the *ESE Register.
*ESR?	n/a	<value> (Range: 0 - 255)	The Standard Event Status Register query returns the value of the Standard Event Status Register.

MPC-203 User Guide

*OPC	n/a	n/a	The Operation Complete command sets bit 0 in the Standard Event Status Register when all pending operations have finished.
*OPC?	n/a	0 or 1	The Operation Complete query returns the ASCII character 1 in the Standard Event Status Register when all pending operations have finished. This query stops any new commands from being processed until the current processing is complete. This command blocks the controller until all operations are complete (i.e. the timeout setting should be longer than the longest sweep).
*SRE	<data> (Range: 0-255)	n/a	Sets the value of the Service Request Enable Register. The variable <data> is the decimal sum of the bits that will be enabled. Bit 6 (value 64) is ignored and cannot be set by this command.
*SRE?	n/a	<value> (Range: 0-63 or 128-191)	The Service Request Enable query returns the value of the Service Request Enable Register.
*STB?	n/a	<value> (Range: 0-255)	The Read Status Byte query returns the value of the status byte without erasing its contents.
*PSC	0 or 1	n/a	The Power-On Status Clear command controls the automatic power-on clearing of the Service Request Enable Register, the Standard Event Status Enable Register, and device-specific event enable registers. (1) Enable. (0) Disable.
*PSC?	n/a	0 or 1	The Power-On Status Clear query returns the flag setting as enabled by the *PSC command.
*CLS	n/a	n/a	Clear Status. Clears the status byte by emptying the error queue and clearing all the event registers including the Data Questionable Event Register, the Standard Event Status Register, the Standard Operation Status Register and any other registers that are summarized in the status byte.

Table 3 SCPI Error and Status Codes

Command Errors	
Error code	Description
-100	"Command error": this is the generic syntax error code used if the device cannot detect more specific errors.
-102	"Syntax error": command improperly formatted.
-109	"Missing parameter": values or parameters needed in command are missing.
-110	"Command header error": command does not contain the expected header.
-113	"No header matched": cannot find matched header
-120	"Numeric data error": value or parameter needed in command is out of range or is not a numeric character.
-144	"Characteristic data too long": a command or value/parameter in a command is more than 20 characters.

MPC-203 User Guide

Device Specific Errors	
Error code	Description
-300	"Device specific error": this is the generic error code used if the device cannot detect more specific errors in device-dependent commands.
-313	"Calibration data lost": indicates error in loading calibration data.
-315	"Configuration data lost" indicates error in loading configuration data.
-350	"Queue overflow": an error occurred but was not recorded because the error queue was full.
-360	"Communication error": this is the generic communication error code used if the device cannot detect more specific errors.
-363	"Input buffer overflow": The command/query is too long.

Operation/Device Control Status Codes	
Code	Description
-500	Device power on: Device sends this code when it powers on or restarts.
-600	"User request event": Device sends this code when it receives a control command via any interface other than GPIB or local front panel keys.
-700	"Request control event": Device sends this code when it receives a control command via GPIB.
-800	Operation completed

GP Format Commands

As a backward compatibility feature for MPC-101 users who may be replacing an older MPC-101 with an MPC-203, and may have existing control programs for the MPC-101, the MPC-203 will respond to commands in the MPC-101 command format, with a few minor differences.

The GP legacy format command list includes only commands relating to functions available in the MPC-101: manual polarization control, polarization modulation (known as waveform mode in the MPC-101), discrete random scrambling, triangle scrambling, and externally triggered random state generation. It cannot be used to control newer functions not present in the MPC-101, such as Rayleigh or Tornado scrambling.

Manual Control:

Set control voltages to individual channels of the polarization controller.

Units: Volts. No options for phase control in radians or multiples of π .

Range: 0 to 150V.

Polarization Modulation (Waveform):

Amplitude

Units: Volts. No option for phase control in radians or multiples of π .

Range: 0 to 45V.

MPC-203 User Guide

Notes:

1. For the MPC-101, the waveform amplitude setting corresponds to V_{pp} (peak to peak voltage variation for the waveform). For the MPC-203, the waveform amplitude setting corresponds to $V_{pp}/2$. Therefore, any MPC-101 programs involving the waveform function need to have the amplitude settings modified before use with the MPC-203.
2. The MPC-101 has no offset control. Any waveform functions set up using the GP legacy command format will have $\text{offset} = A$ (the default setting). In other words, the voltage swing will be 0 to $2A$, where A is the amplitude setting.

Frequency:

Units: Hz

Range: 0 to 1000 Hz.

Other than the range, there are no changes from the MPC-101 frequency setup.

Waveform type:

Options: Sine, Triangle, Square

No changes from MPC-101 waveform type setup.

Phase:

Units: Degree

Range: 0 to 360

Defines the starting phase position of the waveform.

Polarization Scrambling:

There are separate command sets for discrete random scrambling and for continuous triangle scrambling. Each command set includes scrambling rate setup, an enable/resume command, and a disable/pause command. Note that the enable and disable commands are scrambling-type-specific, i.e. if the MPC-203 was paused in random scrambling, and the triangle mode enable command is sent, it will begin triangle scrambling.

Newer scrambling types such as Rayleigh and Tornado cannot be set up from the GP legacy command list.

Externally Triggered Random State Generation:

The *EXT# command puts the MPC-203 into externally triggered random state generation mode. The MPC-203 will generate one random SOP per trigger pulse received. Rising/falling edge selection can be done using the front panel controls. There is no edge selection command available in this list.

MPC-203 User Guide

Table 4 GP Format Commands

System Information		
Command	Description	Response
*IDN?	Query product identification.	*GeneralPhotonics,MPC-203,V1.1-20170417, 192000000001#
*VER?	Query Firmware Version.	*1.1-20170417# Version dependent
*ADR?	Query GPIB address.	*5# if address is 5
*ADR NN#	Set the GPIB Address Range: 1 to 30 Example: *ADR 10#	*E00#
*MOD?	Query current operation mode	Possible responses: *PAN#: Manual Control Mode *WAV# Modulation Mode *SCR#: Scrambling Mode *TGR#: Trigger Mode *ADR#: GPIB Setup Mode
Manual Control		
The first valid Voltage Command received will set the MPC-203 to Manual Control Mode.		
Command	Description	Response/Example
*CV1 FFF#	Set Channel 1 Voltage Range: 0.0 to 150.0 V	Example: *CV1 42.4#
*CV2 FFF#	Set Channel 2 Voltage Range: 0.0 to 150.0 V	Example: *CV2 140.3#
*CV3 FFF#	Set Channel 3 Voltage Range: 0.0 to 150.0 V	Example: *CV3 8.5#
*CV4 FFF#	Set Channel 4 Voltage Range: 0.0 to 150.0 V	Example: *CV4 100.0#
*CHV?	Query control voltages of all channels. Units: Volts	Response: *V1,V2,V3,V4# Example: *23.0,18.5,21.3,0.0#
Modulation (individual channel waveforms) Mode		
The Amplitude, Frequency and Waveform Type of each channel can be independently set. The first valid Waveform Command received will set the MPC-203 to Modulation Mode.		
Amplitude		
Command	Description	Response/Example
*WA1 FFF#	Set channel 1 waveform amplitude. Range: 0.0 to 45.0 V	Example: *WA1 21.5#
*WA2 FFF#	Set channel 2 waveform amplitude. Range: 0.0 to 45.0 V	Example: *WA2 30.0#
*WA3 FFF#	Set channel 3 waveform amplitude. Range: 0.0 to 45.0 V	Example: *WA3 3.5#
*WA4 FFF#	Set channel 4 waveform amplitude. Range: 0.0 to 45.0 V	Example: *WA4 10.5#
Frequency		
*WF1 FFF#	Set channel 1 frequency Range: 0.0 to 1000.0 Hz	Example: *WF1 85.5#
*WF2 FFF#	Set channel 2 frequency Range: 0.0 to 1000.0 Hz	Example: *WF2 85.5#
*WF3 FFF#	Set channel 3 frequency Range: 0.0 to 1000.0 Hz	Example: *WF3 120#
*WF4 FFF#	Set channel 4 frequency Range: 0.0 to 1000.0 Hz	Example: *WF4 75.5#
Waveform Type		
*WT1 SIN# *WT1 TRI# *WT1 SQU#	Set channel 1 Waveform Type. SIN = sine wave TRI = triangle wave SQU = square wave	
*WT2 SIN# *WT2 TRI# *WT2 SQU#	Set channel 2 Waveform Type. SIN = sine wave TRI = triangle wave SQU = square wave	
*WT3 SIN# *WT3 TRI# *WT3 SQU#	Set channel 3 Waveform Type. SIN = sine wave TRI = triangle wave SQU = square wave	

MPC-203 User Guide

*WT4 SIN# *WT4 TRI# *WT4 SQU#	Set channel 4 Waveform Type. SIN = sine wave TRI = triangle wave SQU = square wave	
Waveform Query		
*WC1?	Query waveform settings Channel 1	Return: *amplitude,frequency,wavetype# Example: *23.5,12.5,TRI#
*WC2?	Query waveform settings Channel 2	Return: *amplitude,frequency,wavetype# Example: *3.5,12.5,TRI#
*WC3?	Query waveform settings Channel 3	Return: *amplitude,frequency,wavetype# Example: *23.5,6.5,SIN#
*WC4?	Query waveform settings Channel 4	Return: *amplitude,frequency,wavetype# Example: *29.5,18.4,SQU#
Scrambling Mode		
The first valid Scramble Command received will set the MPC-203 to Scramble Mode		
*RAN FFFF#	Set random scrambling rate to FFFF. Range: 0.01 to 20000.00 points/s	Example: *RAN 123.56#
*RAN ENA#	Enable random scrambling at current scrambling rate setting. Resumes a paused operation.	
*RAN DIS#	Disable random scrambling. Pauses random scrambling operation.	
Triangle Scrambling Mode		
*TRI FFFF#	Set triangle scrambling rate to FFFF. Range: 0.01 to 2000.00 $\times 2\pi$ rad/s	Example: *TRI 123.56#
*TRI ENA#	Enable triangle scrambling at current scrambling rate setting. Resumes paused operation.	
*TRI DIS#	Disable triangle scrambling. Pauses triangle scrambling operation.	
*SCR?	Query the Scramble Mode Setting	Return: *frequency,mode# Example: *10.0,TRI#
External Trigger Mode		
*EXT#	Set MPC-203 to external trigger mode. MPC-203 will generate a random SOP on receiving a TTL trigger pulse.	

Table 5 Command Response Codes

E00	No error (Correct command received)
E01	Undefined Command
E02	Missing parameter
E03	Invalid syntax found in command string
E04	String of characters too long (>buffer limit)
E05	Parameter has too many digits after the decimal point
E06	Parameter outside the allowed range
E07	Failed Self Test
E08	Power too high
E09	Power too low
E10	Incorrect operating wavelength (Outside the operating wavelength range)
E11	Error loading stored values
E12	Unable to store state

MPC-203 User Guide

Scrambling Control Sequence:

To pause and resume a triangle scrambling function, a user would send the following sequence of commands:

1. *TRI 10.0# Set scrambling rate to $10.0 \times 2\pi$ rad/s.
2. *TRI ENA# Begin scrambling.
3. *TRI DIS# Pause scrambling.
4. *TRI ENA# Resume scrambling.

Commands 3 and 4 can be repeated as many times as necessary.

Note that the rate setting command only sets the scrambling rate. If scrambling is already enabled, the rate of the ongoing operation can be changed without re-sending the "enable" command. However, if scrambling is not yet enabled, the "enable" command is necessary to begin scrambling.

Appendix 2.0 RS-232 connection and setup

1. The RS-232 connector on the rear panel of the MPC-203 is a DB9 male connector. Use a straight (not cross connected) RS-232 cable with DB9 female connectors to connect the MPC-203 to the control computer.

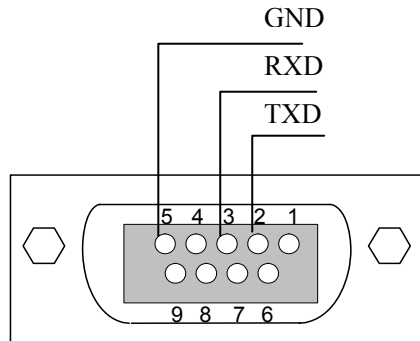

Figure 27 RS-232 connector pin assignment on MPC-203 rear panel.

2. Power on the instrument.
3. Set the RS-232 baud rate. From the main menu, select "System Setup" (option 5), and then "RS-232 Setup" (option 5i).
4. Select the command type (System Setup → Comm Type) and, for SCPI, command EOS.
5. Send a command string to the instrument (See Appendix 1 for commands. Any program that supports RS-232 communication protocols can be used to send ASCII commands to the instrument. Many programming languages support serial communications, including Visual Basic, LabView and C.

RS-232 settings:

RS-232 port uses asynchronous framing, 8 data bits, no parity bit, and 1 stop bit.

RS-232 baud rate: configurable. Default is 9600 bps.

Appendix 3.0 USB connection and setup

USB drivers are included in the "USB Driver" folder on the cd. They need to be installed before USB communication can be established. The first time the USB is used, insert the cd into the control computer.

Connect the MPC-203 to the control computer using a standard USB cable.

Power on the MPC-203.

USB Driver Installation

The first time the computer detects a USB connection to the instrument, the driver may install automatically (Windows 7) or a "Found New Hardware Wizard" window may appear (Windows XP). If neither of these things occur, the driver can be located and installed using Device Manager.

1. Open Device Manager. Look for "FT245R USB FIFO" under "Other Devices". Right-click it and select "Update Driver Software".

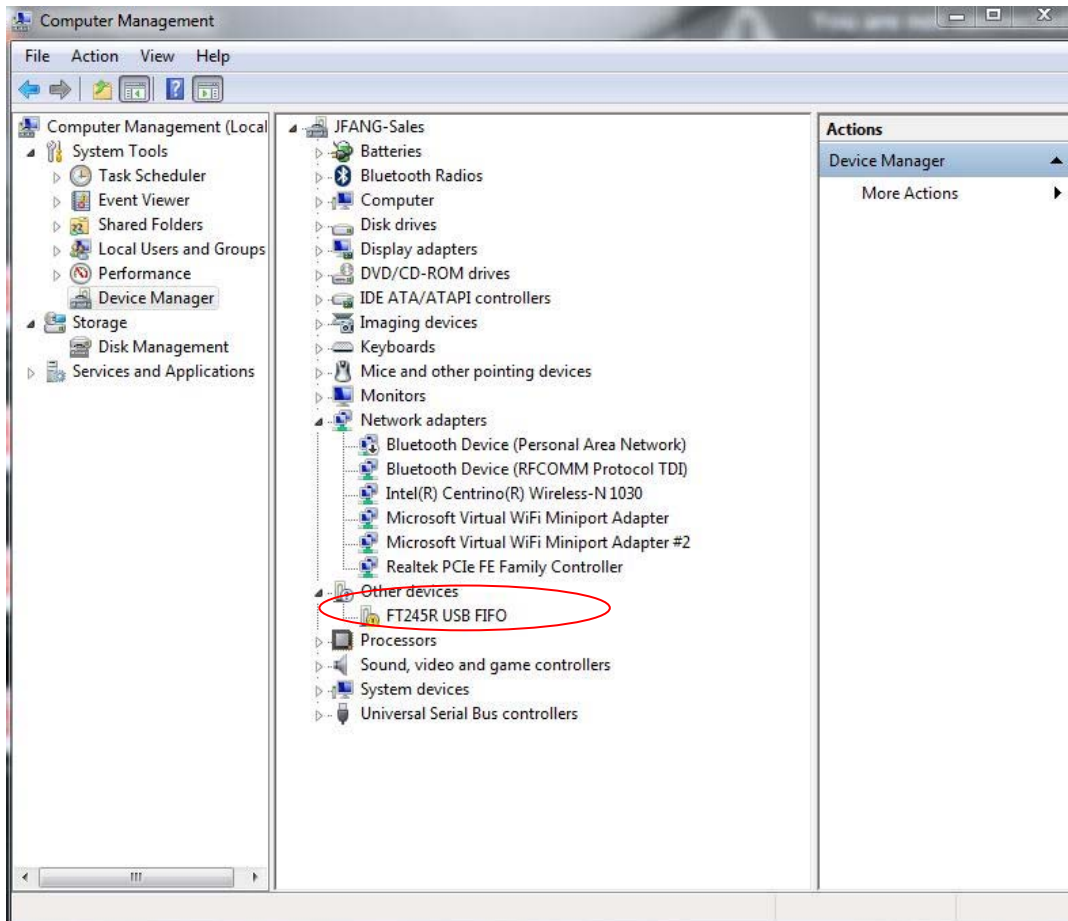

MPC-203 User Guide

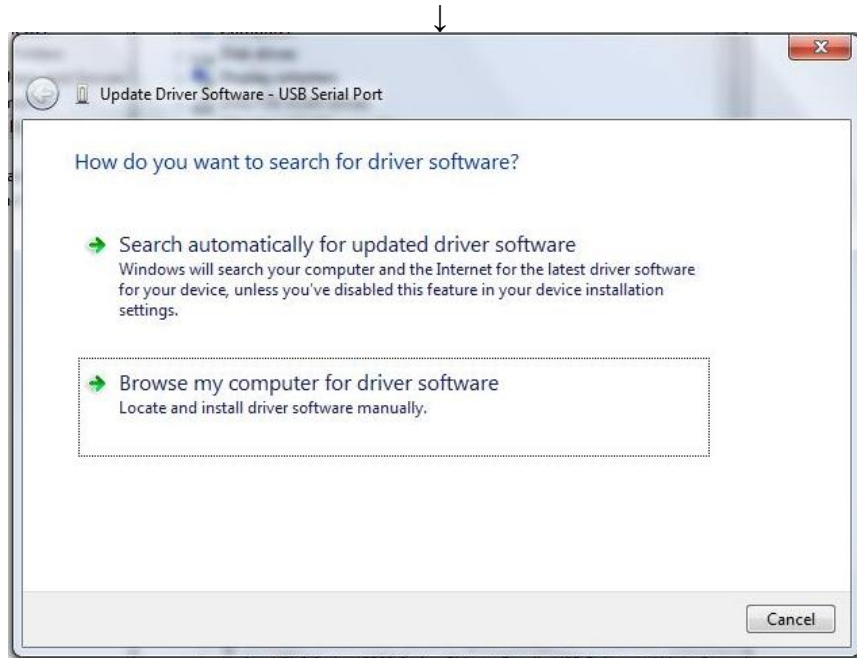
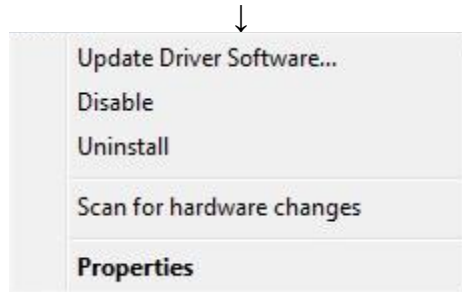

2. Select "Browse my computer for driver software":



MPC-203 User Guide

3. Make sure that the software cd is inserted. Click "Browse", navigate to the cd drive, and select the "USB Driver" folder. Make sure the "include subfolders" box is checked. Click "Next".



4. The computer will ask whether to install the software. Click "Install".

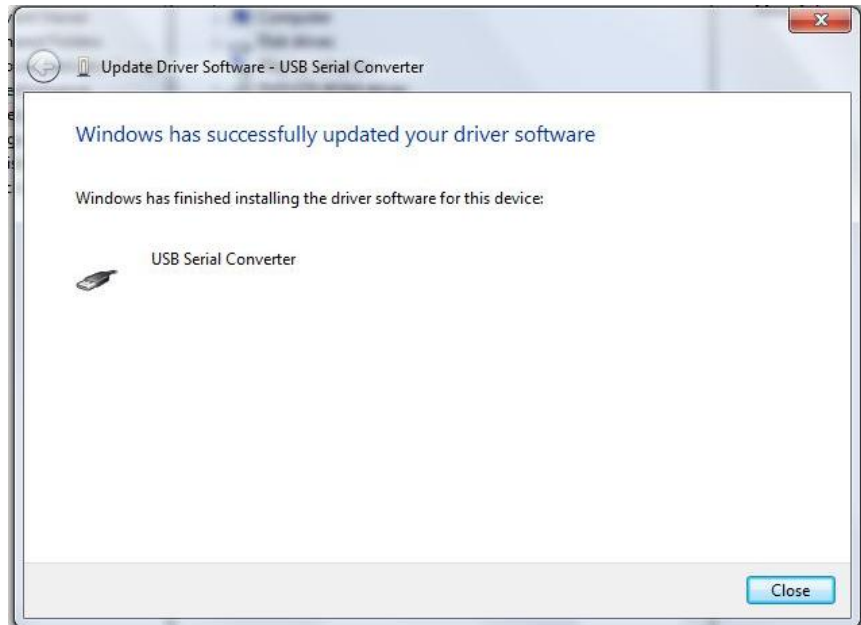

5. When the installation is finished, a "software successfully updated" message will appear. This completes the first part of the installation, during which the USB to serial converter is installed. The second part consists of the installation of the serial port driver.

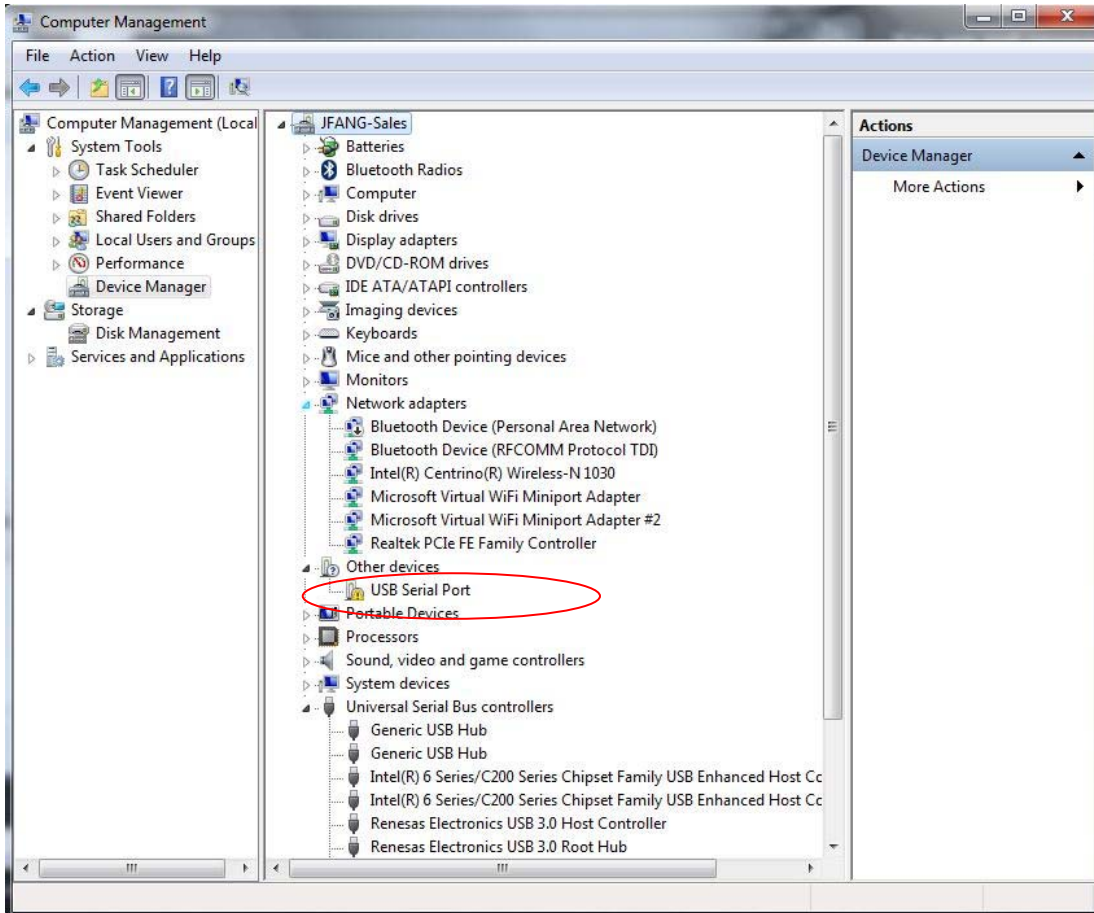

6. In Device Manager, "USB Serial Port" should now appear under "Other Devices". Right-click it and select "Update Driver Software". Follow the same procedure as described above to specify the driver location and install the driver until the completion window for the USB serial port appears:

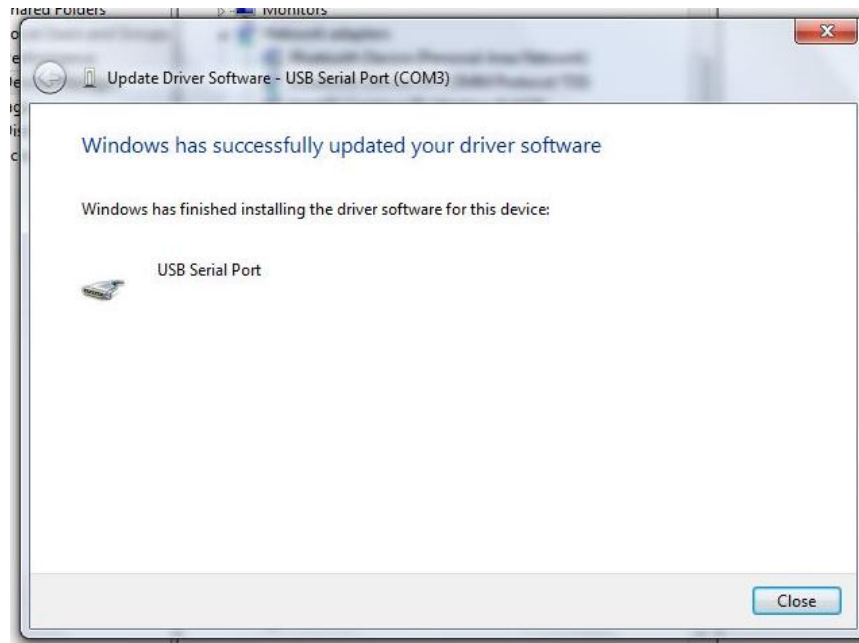

7. In "Device Manager", there should now be a USB Serial Port listed under "Ports (COM & LPT)":

MPC-203 User Guide

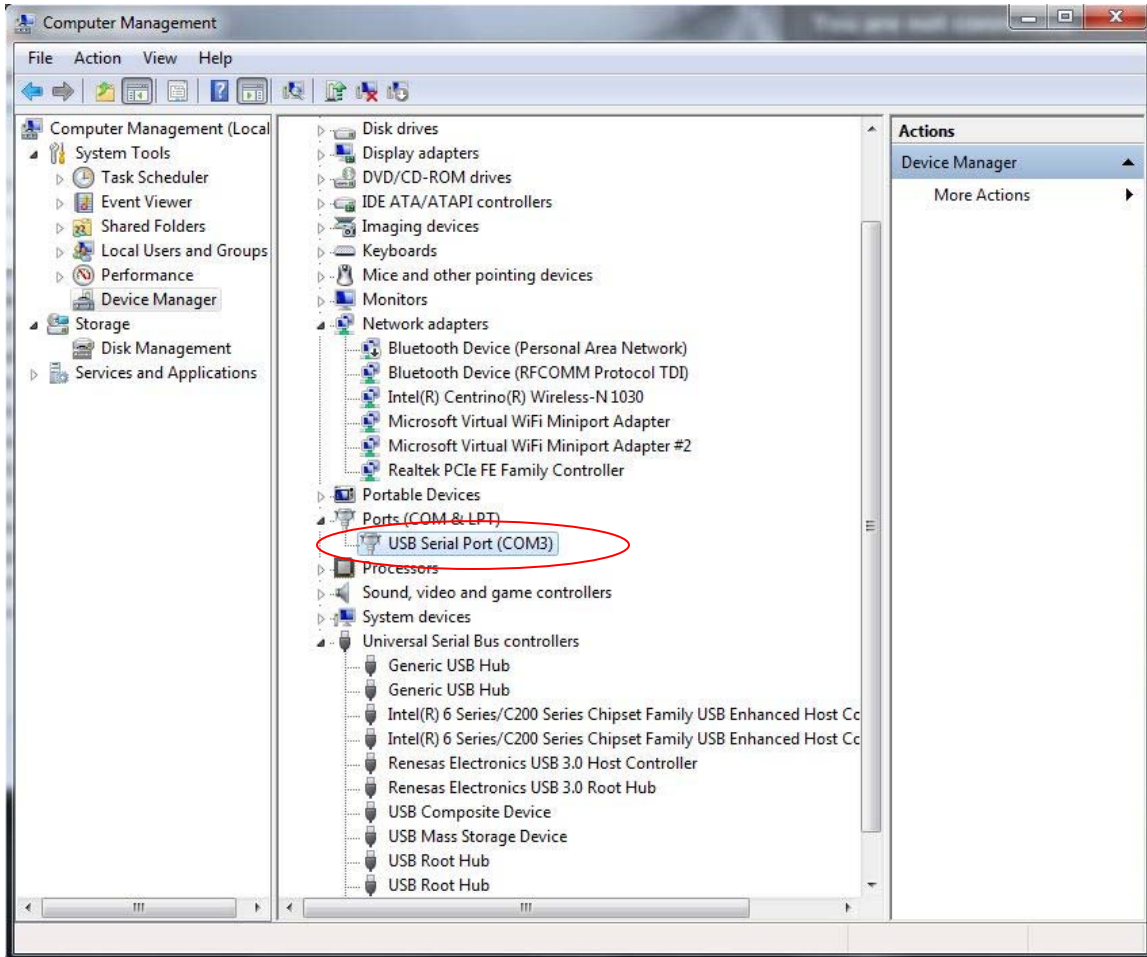

Note the port number that the MPC-203 is using (COM3, in this example).

The USB driver can drive more than one instrument, but the instruments will be connected under different port numbers.

Appendix 4.0 Ethernet setup

There are two connection configurations for Ethernet control:

- a) Static IP: the administrator assigns the instrument a fixed IP address. In this mode the instrument can be directly connected to the control PC, as shown in Figure 28. For this configuration, a cross-linked network cable must be used.
- b) Dynamic IP: the DHCP server assigns the instrument an available address when requested. Connect the instrument with a DHCP server (running on router or exchange server), as shown in Figure 29. For this configuration, a standard straight-linked network cable must be used.

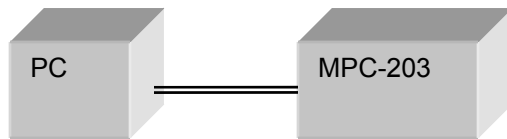

Figure 28 Direct connection: MPC-203 to PC

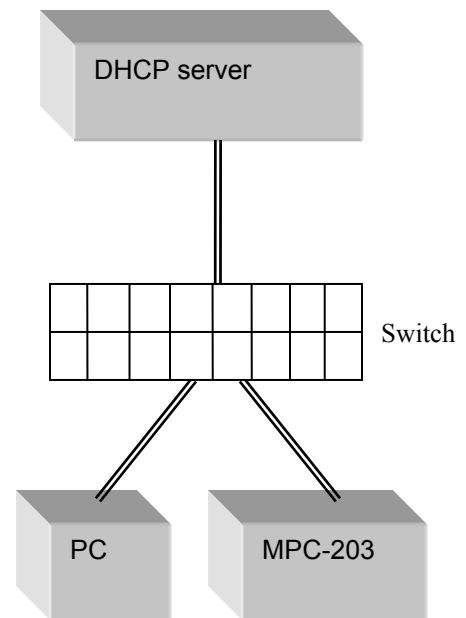

Figure 29 Connection with DHCP server

Once the physical connections are established, the instrument's Ethernet configuration can be set up from the front panel.

MPC-203 Setup for Ethernet communication:

The "Dynamic IP" function in the setup menu sets the MPC-203 for dynamic IP addressing and requests a dynamic IP address from the DHCP server. The "Static IP" function in the setup menu sets the MPC-203 for static IP addressing and allows the user to set the static IP address, net mask, gateway, and name server. See section 3.3 for a more detailed description.

MPC-203 User Guide

The MPC-203 writes its most recently saved static IP settings and its active mode to memory. If it is powered off while in static mode, when it is powered back on, it will be in static mode, and the most recently saved set of IP configuration information can be used for communication.

If the MPC-203 is powered off while in dynamic IP mode, when it is powered back on, it will be in dynamic IP mode. However, it is still necessary to use the "Dynamic IP" function in the setup menu to request a new dynamic IP address.

For static IP control, the net mask and gateway for the instrument should be the same as those for the control computer. The first 3 groups of numbers in the IP address should be the same as those for the control computer (192.168.2, for example). The last number can be any available number, but cannot be the same as the IP address of the control computer. The range of numbers is 1 to 254. If the computer's IP address is 17, for example, the user can set the IP address for the MPC-203 to any number in the range 1-254 except 17.

For static IP control, make sure that the control computer is also set to use a static (defined) IP address (check the TCP/IP properties to find the computer's Ethernet setup information).

For dynamic IP control, make sure that the control computer is set to obtain its IP address automatically. This information is also under TCP/IP properties.

- To connect the instrument directly to a PC, use a PC to PC cable. To connect the instrument to a LAN, use a standard network cable.

Appendix 5.0 GPIB setup and control

Setting the GPIB Address

To set the instrument's GPIB address:

Main menu → System setup (option 5) → GPIB addr (option 5f)

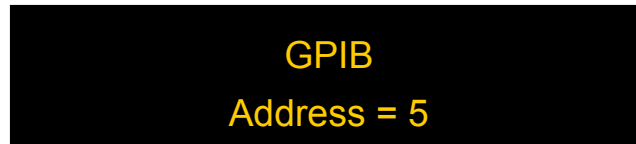

Rotate the wheel to change the GPIB address. The GPIB address changes in real time as the value is changed, and the address is retained in memory after power-off.

Range: 1-30

Default: 5

GPIB control

Connect the instrument to the computer with a GPIB cable. After determining/setting the MPC-203's GPIB address, select the corresponding port number in the corresponding box of the LabView control program (see Appendix 6) and run the control program.

In addition to using the provided control programs, individual commands can be sent through the GPIB port. Enter the GPIB address in the communication program being used. The instrument will then be ready to receive commands. The command lists, responses, and error codes are given in Table 1 through Table 5 in Appendix 1.

To ensure proper communication, use a GPIB cable that is fully compatible with the IEEE 488.1 standard. All GPIB/IEEE 488 interface connections must be made before turning on the instruments.